



## **Long fibre reinforced polyamides**

**Materials with spine**

**GRIVORY<sup>®</sup>**  
**EMS**

**Grilamid<sup>®</sup>**  
**EMS**

**GRILON<sup>®</sup>**  
**EMS**



- 3** Introduction
- 4** Product portfolio / Nomenclature / Manufacturing process
- 5** Characteristics and properties of long fibre reinforced polyamides
  
- 7** Properties Grivory HT
- 8** Properties Grivory GV
- 12** Properties Grilamid L / Grilamid TR
- 14** Properties Grilon
- 16** Special properties
  
- 19** Design data – Short-term behaviour
- 21** Design data – Long-term behaviour
- 23** Heat ageing / Products reinforced with long carbon fibres
- 25** Hybrid-reinforced LFT products
- 26** Resistance to chemicals
  
- 29** Flame behaviour / Storage and drying
- 30** Processing - Injection moulding
- 32** Mould design
- 34** Processing parameters
- 36** Processing - Post-treatment
- 39** Customer services and technical support
- 40** Make use of our test laboratories
- 41** Quality standards
- 42** EMS-GRIVORY products
- 43** Delivery form



### Long fibre reinforced polyamides – Materials with spine

Long fibre reinforced polyamides from EMS-GRIVORY make metal replacement possible in new and challenging fields of application.

The long reinforcement fibres form a fibre web inside the injection-moulded components which provides sustainably improved thermo-technical properties. Stresses are transferred more or less directly to the fibres which are interlinked with each other. In this way, changes in property values in dependence of temperature, moisture or deformation speed are reduced and utilisation limits are pushed higher.

Long fibre reinforced polyamides from EMS-GRIVORY are based on the well-known high-performance materials in the range of product families including:

- **Grivory HT1**  
High-temperature polyamides based on PPA (polyphthalamide)
- **Grivory GV**  
Partially crystalline polyamides with aromatic shares
- **Grilamid L**  
Polyamide 12
- **Grilamid TR**  
Amorphous / transparent polyamides
- **Grilon TS**  
Polyamide 66+6 grades

Glass or carbon fibres are used as reinforcement. Product grades differ in the type and composition of the polyamides used as well as the kind and amount of fibres used.

Long fibre reinforced polyamides from EMS-GRIVORY are used in the production of challenging technical components which have special requirements with regard to the following material properties:

- good mechanical properties above the glass transition temperature
- low creep
- high strength values under very rapid deformation
- improved notched impact strength without loss of stiffness
- low warpage

Typical polyamide properties such as good resistance to chemicals, good surface quality and extremely efficient manufacture of even complex components, remain unchanged in the long fibre reinforced grades.

Due to the special properties of long fibre reinforced polyamides, this group of materials is predestinated for use in high-quality and challenging metal-replacement applications.

Compared to products reinforced with short fibres, the long fibre structure allows a component to exhibit higher property values at the same temperature or the same property values at temperatures which are 20 to 30°C higher. This allows light-weight structural designs for components with lower wall thicknesses or lower amounts of fibre reinforcement (lower density) to be achieved.

Long fibre reinforced polyamides are just as physiologically harmless as the basic polymers. Products approved for use in contact with foodstuffs are also available.



**The product portfolio of long fibre reinforced polyamides**

- **Grivory HTVL**  
long glass fibre reinforced Grivory HT1 products
- **Grivory GVL**  
long glass fibre reinforced Grivory GV products
- **Grivory GCL**  
long carbon fibre reinforced Grivory GV products
- **Grivory GXL**  
hybrid long fibre reinforced (GF+CF) Grivory GV products
- **Grilamid LVL**  
long glass fibre reinforced Grilamid L products
- **Grilamid LCL**  
long carbon fibre reinforced Grilamid L products
- **Grilamid TRVL**  
long glass fibre reinforced amorphous Grilamid TR products
- **Grilon TSGL**  
long glass fibre reinforced Grilon TS products
- **Grilon TSGL FA**  
long glass fibre reinforced Grilon TS products, approved for use in contact with foodstuffs
- **Grilon TSXL**  
hybrid long fibre reinforced (GF+CF) Grilon TS products

The XE designation is used for products in the market introduction phase.

**Nomenclature**

Grivory G V L - 6 H black 9915 (reinforced example)

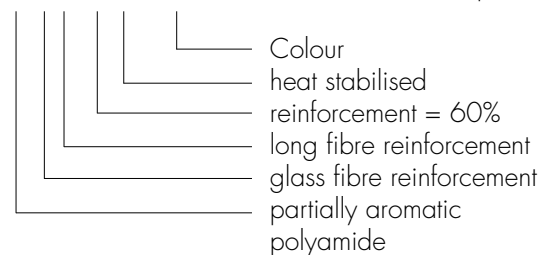

**Manufacture of LFT products**

The long fibre reinforced polyamides from EMS-GRIVORY are manufactured using a special process. The basic raw materials for this are quasi endless glass or carbon fibres which are delivered wound on reels.

These fibres are pre-treated in a specially developed impregnation nozzle assembly where the single fibres are separated and impregnated with a polyamide melt. This melt contains a series of additives (colours, heat stabilisers, flame protection, processing aids) and complete the long reinforcing fibres into a process-ready material.

Each pellet of finished product contains between 4,000 and 24,000 reinforcing fibres, all of exactly the same length as the granule itself - typically 10 mm. The fibres are not coated in a bundle, but are impregnated separately and brought together again in the pellets.

The finished products are delivered as dry pellets ready for processing and packed in 25 kg bags (laminated with aluminium) or in octabins.

## Characteristics and properties of long fibre reinforced polyamides



Grade	Product	Characteristics and properties	Application segment
Basic grades	Grivory HT LFT HT1VL-50X HT1VL-60X	Injection-moulding grades with a balanced property profile, 50% and 60% long glass fibre reinforcement	High stiffness components with high working temperatures, increased requirements on creep and absorption of energy
	Grivory GV LFT GVL-3H GVL-4H GVL-5H GVL-6H	Injection-moulding grades with a balanced property profile, 30% to 60% long glass fibre reinforcement	Stiff, dimensionally accurate components with high requirements on strength and energy absorption, significantly reduced creep, replacement of die-cast metal alloys
High performance grades	GVL-5H HP GVL-6H HP	Injection-moulding grades with further increased property values, 50% and 60% reinforcement with special fibres	Stiff, dimensionally accurate components with high requirements on strength and energy absorption, strength values above 300 MPa
Flame resistant	GVL-4H V0 GVL-5H V0 GVL-6H V0	Injection-moulding grades with flame-retardant additives, UL 94 V-0 and 5VA from 1.6 mm, 40% to 60% long glass fibre reinforcement	Flame-resistant components with special requirements on mechanical properties, impact resistance, creep
Reinforced with carbon fibres	GCL-3H GCL-4H	Injection-moulding grades with very high stiffness, strength and energy absorption, 30% to 40% long carbon fibre reinforcement	Components with very high requirements on mechanical performance and minimum component weight
Reinforced with hybrid fibres	GXL-40 DB GXL-45 DB GXL-50 DB	Injection-moulding grades with hybrid fibre reinforcement (glass and carbon) 40% to 50%	Components with electro-static conductivity in combination with good mechanical properties



■ **Characteristics and properties of long fibre reinforced polyamides**

Grade	Product	Characteristics and properties	Application segment
Basic grades	Grilamid L LFT LVL-5H LVL-6H	Injection-moulding grades with a balanced property profile, 50% to 60% long glass fibre reinforcement	High stiffness components with increased requirements on creep and absorption of energy, highest dimensional stability and resistance to chemicals
	Reinforced with carbon fibres LCL-3H LCL-4H	Injection-moulding grades with very high stiffness, strength and energy absorption, 30% to 40% long carbon fibre reinforcement	Very light-weight components with high requirements on mechanical performance, especially in the field of sport articles
Basic grades	Grilamid TR LFT TRVL-50X9 HP	Amorphous injection-moulding grade with a balanced property profile, 50% long glass fibre reinforcement	Components with very little warpage, very good surface quality, highest dimensional stability
Basic grades	Grilon TS LFT TSGL-30/4 TSGL-40/4 TSGL-50/4 TSGL-60/4	Injection-moulding grades with a balanced property profile, 30% to 60% long glass fibre reinforcement	Stiff components with high requirements on strength and energy absorption, significantly reduced creep, replacement of die-cast metal alloys
	Flame resistant TSGL-30/4 V0 TSGL-40/4 V0 TSGL-50/4 V0	Injection-moulding grades with flame-retardant additives, UL 94 V-0 and 5VA from 1.6 mm, 30% to 50% long glass fibre reinforcement	Flame-resistant components with special requirements on mechanical properties, impact strength, creep
Reinforced with hybrid fibres	TSXL-40/4 DB TSXL-50/4 DB	Injection-moulding grades with hybrid fibre reinforcement (glass and carbon) 40% to 50%	Components with electro-static conductivity in combination with good mechanical properties.

Mechanical Properties				HT1VL-50X black 9839	HT1VL-60X black 9839
Tensile modulus of elasticity	ISO 527	MPa	dry	19500	24500
			cond.	19000	24000
Stress at break	ISO 527	MPa	dry	275	265
			cond.	270	260
Elongation at break	ISO 527	%	dry	1.9	1.5
			cond.	1.9	1.5
Impact strength 23°C	ISO 179/2-1eU	kJ/m <sup>2</sup>	dry	75	75
			cond.	75	75
Impact strength -30°C	ISO 179/2-1eU	kJ/m <sup>2</sup>	dry	75	75
			cond.	75	75
Notched impact strength 23°C	ISO 179/2-1eA	kJ/m <sup>2</sup>	dry	30	30
			cond.	30	30
Notched impact strength -30°C	ISO 179/2-1eA	kJ/m <sup>2</sup>	dry	30	30
			cond.	30	30
Ball indentation hardness	ISO 2039-1	MPa	dry	350	360
			cond.	350	360
<b>Thermal properties</b>					
Melting point	ISO 11357	°C	dry	325	325
Heat distortion temperature HDT/A	ISO 75 A	°C	dry	> 290	> 300
Heat distortion temperature HDT/C	ISO 75 C	°C	dry	250	270
<b>Electrical properties</b>					
Comparative tracking index	IEC 60112		dry	600	600
Specific surface resistivity	IEC 60093	Ω	dry	10 <sup>12</sup>	10 <sup>12</sup>
			cond.	10 <sup>12</sup>	10 <sup>12</sup>
<b>General properties</b>					
Density	ISO 1183	g/cm <sup>3</sup>	dry	1.65	1.78
Flammability (UL 94), 1.6mm	IEC 60695-11-10	Step	dry	HB	HB
Water absorption	ISO 62	%	dry	3.0	2.8
Moisture absorption	ISO 62	%	dry	1.3	1.2
Linear mould shrinkage long.	ISO 294	%	dry	0.10	0.10
Linear mould shrinkage trans.	ISO 294	%	dry	0.20	0.15

Mechanical properties				<b>GVL-4H natural</b>	<b>GVL-4H black 9915</b>
Tensile modulus of elasticity	ISO 527	MPa	dry	14000	14500
			cond.	13000	13500
Stress at break	ISO 527	MPa	dry	240	230
			cond.	205	200
Elongation at break	ISO 527	%	dry	2.5	2.3
			cond.	2.6	2.4
Impact strength 23°C	ISO 179/2-1 eU	kJ/m <sup>2</sup>	dry	85	80
			cond.	80	75
Impact strength -30°C	ISO 179/2-1 eU	kJ/m <sup>2</sup>	dry	75	70
			cond.	75	70
Notched impact strength 23°C	ISO 179/2-1 eA	kJ/m <sup>2</sup>	dry	30	30
			cond.	30	30
Notched impact strength -30°C	ISO 179/2-1 eA	kJ/m <sup>2</sup>	dry	30	25
			cond.	30	25
Ball indentation hardness	ISO 2039-1	MPa	dry	255	265
			cond.	230	250
<b>Thermal properties</b>					
Melting point	ISO 11357	°C	dry	260	260
Heat distortion temperature HDT/A	ISO 75 A	°C	dry	255	250
Heat distortion temperature HDT/C	ISO 75 C	°C	dry	210	210
<b>Electrical properties</b>					
Comparative tracking index	IEC 60112		dry	600	600
Specific surface resistivity	IEC 60093	Ω	dry	10 <sup>10</sup>	10 <sup>10</sup>
			cond.	10 <sup>10</sup>	10 <sup>10</sup>
<b>General properties</b>					
Density	ISO 1183	g/cm <sup>3</sup>	dry	1.47	1.47
Flammability (UL 94), 1.6mm	IEC 60695-11-10	Step	dry	HB	HB
Water absorption	ISO 62	%	dry	4.5	4.5
Moisture absorption	ISO 62	%	dry	1.4	1.4
Linear mould shrinkage long.	ISO 294	%	dry	0.15	0.15
Linear mould shrinkage trans.	ISO 294	%	dry	0.40	0.40



<b>GVL-4H V0 black 9915</b>	<b>GVL-5H natural</b>	<b>GVL-5H HP natural</b>	<b>GVL-5H black 9839</b>	<b>GVL-5H black 9915</b>	<b>GVL-5H V0 black 9915</b>
14500	17500	17500	17500	17500	17500
13500	16500	16800	16500	16500	16500
200	270	290	265	260	235
180	230	265	230	230	210
2.3	2.5	2.6	2.4	2.2	2.2
2.5	2.5	2.5	2.4	2.2	2.2
70	105	115	105	90	90
65	100	110	100	85	85
70	90	100	90	85	85
60	90	100	90	80	80
25	35	40	35	30	30
25	35	40	35	30	30
25	35	40	35	30	30
25	35	40	35	30	30
260	275	275	275	290	290
245	260	260	260	270	270
260	260	260	260	260	260
250	255	255	255	255	255
210	220	220	220	220	220
600	600	600	600	600	600
10 <sup>10</sup>	10 <sup>10</sup>	10 <sup>10</sup>	10 <sup>10</sup>	10 <sup>10</sup>	10 <sup>10</sup>
10 <sup>10</sup>	10 <sup>10</sup>	10 <sup>10</sup>	10 <sup>10</sup>	10 <sup>10</sup>	10 <sup>10</sup>
1.52	1.56	1.56	1.56	1.56	1.59
VO/5VA	HB	HB	HB	HB	VO/5VA
4.2	4.0	4.0	4.0	4.0	3.7
1.4	1.3	1.3	1.3	1.3	1.2
0.10	0.10	0.10	0.10	0.10	0.10
0.30	0.25	0.25	0.25	0.25	0.25

Mechanical properties				<b>GVL-6H natural</b>	<b>GVL-6H HP natural</b>
Tensile modulus of elasticity	ISO 527	MPa	dry	22500	23500
			cond.	21000	21500
Stress at break	ISO 527	MPa	dry	290	315
			cond.	255	275
Elongation at break	ISO 527	%	dry	2.1	2.2
			cond.	2.1	2.3
Impact strength 23°C	ISO 179/2-1eU	kJ/m <sup>2</sup>	dry	115	125
			cond.	115	120
Impact strength -30°C	ISO 179/2-1eU	kJ/m <sup>2</sup>	dry	95	110
			cond.	95	110
Notched impact strength 23°C	ISO 179/2-1eA	kJ/m <sup>2</sup>	dry	40	45
			cond.	40	45
Notched impact strength -30°C	ISO 179/2-1eA	kJ/m <sup>2</sup>	dry	40	45
			cond.	40	45
Ball indentation hardness	ISO 2039-1	MPa	dry	305	315
			cond.	285	285
<b>Thermal properties</b>					
Melting point	ISO 11357	°C	dry	260	260
Heat distortion temperature HDT/A	ISO 75 A	°C	dry	255	255
Heat distortion temperature HDT/C	ISO 75 C	°C	dry	225	230
<b>Electrical properties</b>					
Comparative tracking index	IEC 60112		dry	600	600
Specific surface resistivity	IEC 60093	Ω	dry	10 <sup>10</sup>	10 <sup>10</sup>
			cond.	10 <sup>10</sup>	10 <sup>10</sup>
<b>General properties</b>					
Density	ISO 1183	g/cm <sup>3</sup>	dry	1.69	1.69
Flammability (UL 94), 1.6mm	IEC 60695-11-10	Step	dry	HB	HB
Water absorption	ISO 62	%	dry	3.5	3.5
Moisture absorption	ISO 62	%	dry	1.2	1.2
Linear mould shrinkage long.	ISO 294	%	dry	0.10	0.10
Linear mould shrinkage trans.	ISO 294	%	dry	0.20	0.20

<b>GVL-6H black 9839</b>	<b>GVL-6H black 9915</b>	<b>GCL-3H anthracite</b>	<b>GCL-3H black 9915</b>	<b>GCL-4H anthracite</b>	<b>GXL-40 DB black 9915</b>	<b>GXL-45 DB black 9915</b>
22500	23000	22500	23000	29500	22500	24000
21000	21500	21500	22000	26500	20500	21500
280	280	315	310	335	285	280
250	240	270	270	300	230	230
2.1	2.0	1.5	1.5	1.5	1.7	1.7
2.1	2.0	1.7	1.7	1.6	1.7	1.7
110	100	55	55	65	60	70
105	100	65	65	75	60	70
90	85	55	55	65	70	75
90	85	65	65	75	70	75
40	35	16	15	18	17	20
40	35	16	15	18	17	20
40	35	20	19	20	20	23
40	35	20	19	20	20	23
310	315	320	330	340	320	340
285	290	285	295	310	300	310
260	260	260	260	260	260	260
255	255	255	255	255	255	255
225	225	240	240	240	225	235
600	600	-	-	-	-	-
10 <sup>10</sup>	10 <sup>10</sup>	<50	<50	<50	<100	<100
10 <sup>10</sup>	10 <sup>10</sup>	<50	<50	<50	<100	<100
1.69	1.69	1.28	1.28	1.34	1.40	1.41
HB	HB	HB	HB	HB	HB	HB
3.5	3.5	4.7	4.7	4.5	4.5	4.2
1.2	1.2	1.5	1.5	1.3	1.4	1.2
0.10	0.10	0.00	0.00	0.00	0.05	0.05
0.20	0.20	0.10	0.10	0.10	0.20	0.15

■ **Properties**  
**Grilamid L / Grilamid TR**

<b>Mechanical properties</b>			
Tensile modulus of elasticity	ISO 527	MPa	cond.
Stress at break	ISO 527	MPa	cond.
Elongation at break	ISO 527	%	cond.
Impact strength 23°C	ISO 179/2-1eU	kJ/m <sup>2</sup>	cond.
Impact strength -30°C	ISO 179/2-1eU	kJ/m <sup>2</sup>	cond.
Notched impact strength 23°C	ISO 179/2-1eA	kJ/m <sup>2</sup>	cond.
Notched impact strength -30°C	ISO 179/2-1eA	kJ/m <sup>2</sup>	cond.
Ball indentation hardness	ISO 2039-1	MPa	cond.
<b>Thermal properties</b>			
Melting point	ISO 11357	°C	dry
Heat distortion temperature HDT/A	ISO 75 A	°C	dry
Heat distortion temperature HDT/C	ISO 75 C	°C	dry
<b>Electrical properties</b>			
Comparative tracking index	IEC 60112		dry
Specific surface resistivity	IEC 60093	Ω	dry cond.
<b>General properties</b>			
Density	ISO 1183	g/cm <sup>3</sup>	dry
Flammability (UL 94), 1.6mm	IEC 60695-11-10	Step	dry
Water absorption	ISO 62	%	dry
Moisture absorption	ISO 62	%	dry
Linear mould shrinkage long.	ISO 294	%	dry
Linear mould shrinkage trans.	ISO 294	%	dry

	<b>LVL-5H natural</b>	<b>LVL-6H natural</b>	<b>LCL-3H anthracite</b>	<b>LCL-4H anthracite</b>	<b>TRVL-50X9 HP natural</b>
	13500	17000	19000	24000	15500
	200	215	250	260	215
	2.5	2.3	1.7	1.6	2.3
	100	100	70	75	95
	100	100	70	75	95
	45	45	28	30	35
	45	45	28	30	35
	195	210	200	220	220
	178	178	178	178	-
	175	175	170	170	140
	155	160	160	160	125
	600	600	-	-	600
	10 <sup>12</sup>	10 <sup>12</sup>	<50	<50	10 <sup>12</sup>
	10 <sup>12</sup>	10 <sup>12</sup>	<50	<50	10 <sup>12</sup>
	1.47	1.59	1.15	1.21	1.50
	HB	HB	HB	HB	HB
	0.8	0.7	1.1	0.9	1.0
	0.4	0.3	0.6	0.5	0.3
	0.25	0.20	0.00	0.00	0.05
	0.35	0.30	0.10	0.10	0.10

■ **Properties  
Grilon**

# 14

Mechanical properties				<b>TSGL-30/4 black 9833</b>	<b>TSGL-40/4 natural</b>	<b>TSGL-40/4 black 9833</b>
Tensile modulus of elasticity	ISO 527	MPa	dry	10000	13000	13500
			cond.	7400	9500	10000
Stress at break	ISO 527	MPa	dry	190	230	220
			cond.	135	165	160
Elongation at break	ISO 527	%	dry	2.3	2.6	2.0
			cond.	2.6	2.8	2.5
Impact strength 23°C	ISO 179/2-1eU	kJ/m <sup>2</sup>	dry	55	85	75
			cond.	60	85	80
Impact strength -30°C	ISO 179/2-1eU	kJ/m <sup>2</sup>	dry	55	65	60
			cond.	60	65	65
Notched impact strength 23°C	ISO 179/2-1eA	kJ/m <sup>2</sup>	dry	20	30	30
			cond.	25	30	30
Notched impact strength -30°C	ISO 179/2-1eA	kJ/m <sup>2</sup>	dry	20	30	30
			cond.	25	30	30
Ball indentation hardness	ISO 2039-1	MPa	dry	240	280	280
			cond.	165	180	180
<b>Thermal properties</b>						
Melting point	ISO 11357	°C	dry	260	260	260
Heat distortion temperature HDT/A	ISO 75 A	°C	dry	245	250	250
Heat distortion temperature HDT/C	ISO 75 C	°C	dry	195	230	230
<b>Electrical properties</b>						
Comparative tracking index	IEC 60112		dry	600	600	600
Specific surface resistivity	IEC 60093	Ω	dry	10 <sup>12</sup>	10 <sup>12</sup>	10 <sup>12</sup>
			cond.	10 <sup>11</sup>	10 <sup>11</sup>	10 <sup>11</sup>
<b>General properties</b>						
Density	ISO 1183	g/cm <sup>3</sup>	dry	1.35	1.45	1.45
Flammability (UL 94), 1.6mm	IEC 60695-11-10	Step	dry	HB	HB	HB
Water absorption	ISO 62	%	dry	5.5	5.0	5.0
Moisture absorption	ISO 62	%	dry	2.1	1.8	1.8
Linear mould shrinkage long.	ISO 294	%	dry	0.20	0.15	0.15
Linear mould shrinkage trans.	ISO 294	%	dry	0.45	0.35	0.35

<b>TSGL-40/4 FA black 9840</b>	<b>TSGL-50/4 natural</b>	<b>TSGL-50/4 black 9839</b>	<b>TSGL-50/4 black 9833</b>	<b>TSGL-60/4 natural</b>	<b>TSGL-60/4 black 9839</b>	<b>TSGL-60/4 black 9833</b>	<b>TSXL-40 DB</b>	<b>TSXL-50 DB</b>
13500	17500	17500	17800	22000	22000	22500	14000	17500
10000	12500	12500	12500	16500	16500	17000	10500	13500
220	265	260	255	275	275	270	225	240
160	180	180	180	200	200	200	165	185
2.0	2.4	2.3	2.0	2.1	2.1	2.0	2.0	2.0
2.5	2.6	2.5	2.3	2.2	2.2	2.2	2.4	2.4
75	100	100	95	110	110	100	55	80
80	105	105	100	110	110	110	65	75
60	95	95	85	105	105	95	55	75
65	75	75	80	95	95	90	65	75
30	40	40	35	40	40	35	20	30
30	45	45	40	45	45	40	25	30
30	40	40	35	40	40	35	20	30
30	45	45	40	40	45	40	25	30
280	310	310	315	350	340	350	290	320
180	200	200	200	230	230	240	215	265
260	260	260	260	260	260	260	260	260
250	250	250	250	255	255	255	255	255
230	230	230	230	235	235	235	230	235
600	600	600	600	600	600	600	-	-
10 <sup>12</sup>	10 <sup>12</sup>	10 <sup>12</sup>	10 <sup>12</sup>	10 <sup>12</sup>	10 <sup>12</sup>	10 <sup>12</sup>	<10 <sup>8</sup>	<10 <sup>8</sup>
10 <sup>11</sup>	10 <sup>11</sup>	10 <sup>11</sup>	10 <sup>11</sup>	10 <sup>11</sup>	10 <sup>11</sup>	10 <sup>11</sup>	<10 <sup>8</sup>	<10 <sup>8</sup>
1.45	1.55	1.55	1.55	1.68	1.68	1.68	1.44	1.53
HB	HB	HB	HB	HB	HB	HB	HB	HB
5.0	4.5	4.5	4.5	4.0	4.0	4.0	5.0	5.0
1.8	1.5	1.5	1.5	1.2	1.2	1.2	1.8	1.5
0.15	0.10	0.10	0.10	0.10	0.10	0.10	0.10	0.10
0.35	0.30	0.30	0.30	0.25	0.25	0.25	0.30	0.25

## ■ Special properties



### Special properties of EMS-GRIVORY LFT polyamides

The fibre-web structure created inside the component is responsible for a whole series of improved thermomechanical properties. This means, that LFT polyamides belong in the property range of fibre composites.

LFT polyamides show significantly improved property values, especially in the areas of:

- creep
- notched impact strength / energy absorption
- behaviour under high deformation speeds
- behaviour at high temperatures
- behaviour at very low temperatures
- fatigue strength

This is due to a more direct transfer of stress in the components between the fibres and widens the range of possible uses, particularly in the field of challenging metal replacement applications.

### Behaviour under tensile load

All EMS-GRIVORY LFT products, independent of their basic polyamide, show clearly more linear behaviour

in tensile tests and greater elasticity to change shape. This results in generally higher strengths throughout the temperature range. Higher stiffness values are also achieved above the glass transition point.

The improved strength and stiffness values of LFT grades are clearly visible at higher temperatures. Using partially aromatic Grivory GVL with 60% glass-fibre reinforcement the behaviour of the long glass fibre reinforced material is practically the same at 120°C as the standard grade at only 80°C. This also offers the opportunity of using around 10% less long glass fibres to achieve properties similar to those of a standard compound and in doing so, achieving a component with less density and therefore, lighter in weight.

A similar effect can be achieved regarding stiffness depending on temperature. Up to glass transition temperatures, LFT products show similar values to those of standard compounds. At temperatures above the glass transition point, they exhibit significantly higher values for the modulus of elasticity. Due to the long-fibre structure, the components are less yielding and have a higher capacity for reversible deformation, making it possible to use lower amounts of reinforcing fibres to achieve the necessary E-modulus values.

Tensile tests as per ISO 527 / dry

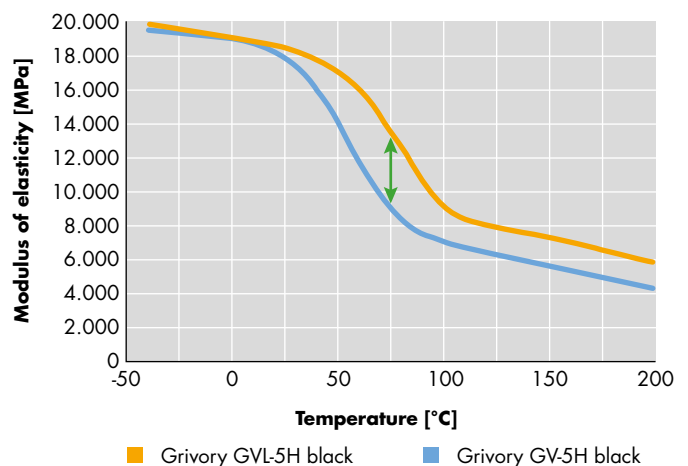
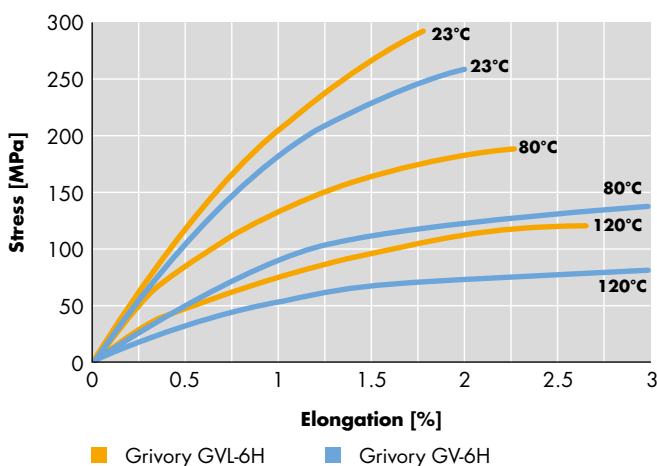





The long-fibre structure also provides 20% to 30% higher stiffness at temperatures above room temperature. In this way, using around 10% less reinforcing fibre, a compound is created with similar E-modulus values to those of a standard product containing higher quantities of short reinforcing fibres. From the diagram it can also be clearly seen that the same stiffness values can be achieved at much higher temperatures. This temperature advantage is maintained to a correspondingly high heat distortion temperature.

#### Notched impact strength / Energy absorption

All long fibre reinforced polyamides exhibit clearly higher notched impact strength values compared to normal compounds. Here also, the explanation is based on the fibre-web structure which provides higher crack propagation resistance and allows the component to absorb two to three times as much energy before it breaks.

Notched impact strength ISO 179 / dry

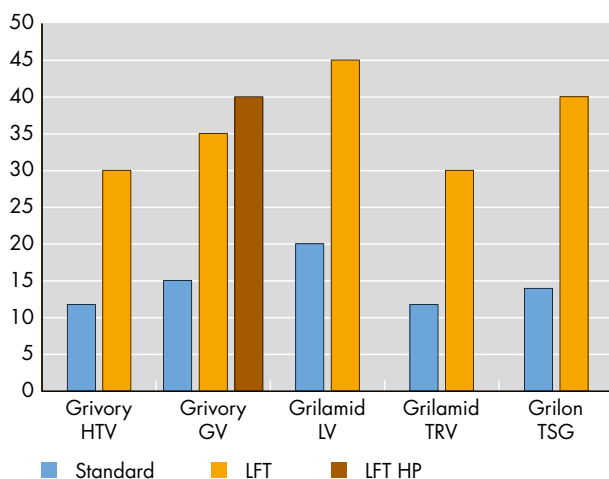

This significantly higher notched impact strengths (or in general, energy absorption) is not achieved however, through a loss in stiffness. LFT polyamides combine an unchanged high modulus of elasticity with excellent notched impact strength values.

#### Higher notched impact strength, no compromises

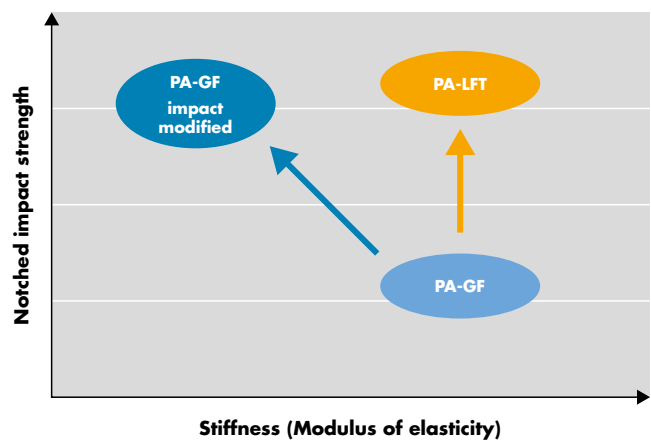

These values remain practically constant over a very wide temperature range and no brittleness occurs, even at very low temperatures. LFT polyamides have practically the same notched impact strength values at -40°C as at 23°C.

In penetration tests, LFT products also show a different kind of breakage structure. The components do not split or form fragments, breakage occurs after around 3-fold energy absorption levels with a hinge break.



## Special properties



### Resistance to creep

Significantly lower deformation due to creep is achieved using the long fibre reinforced polyamides from EMS-GRIVORY. Here also, the reason is the special fibre matrix inside the injection-moulded parts. The fibres support each other and prevent yield. Well-known for its lowest creep values,

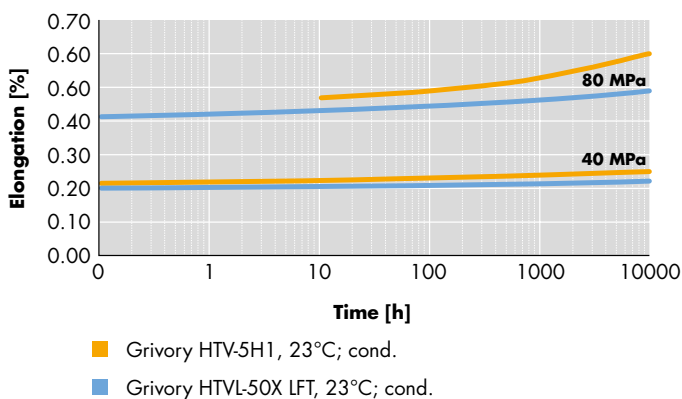

Grivory HTV-5H1, can have its performance property values improved once again through use of long glass fibres. Grivory HTVL-50 exhibits clearly reduced creep values, especially under high stress, and has a much longer period of time until deformation can be seen.

### Heat distortion temperature

Similar to key mechanical values, higher values can also be seen for heat distortion temperatures of long

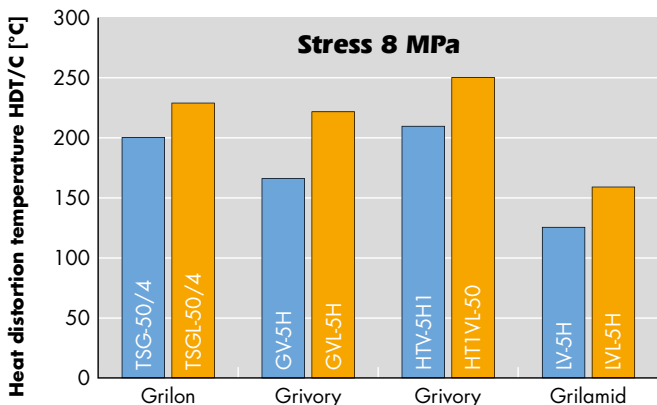

fibre reinforced polyamides. The fibre structure delays yield of the material to much higher temperatures for all product families.

### Shrinkage and warpage

Long fibres are not as strongly oriented in injection-moulded components as short reinforcement fibres in standard compounds. Overall, this gives the components fewer direction-dependant properties and therefore, lower warpage during injection-moulding processes. In the main direction of flow, LFT polyamides exhibit slightly more shrinkage, transversely however, significantly less shrinkage can be seen. This statement also applies to the coefficient of thermal elongation and mechanical properties.

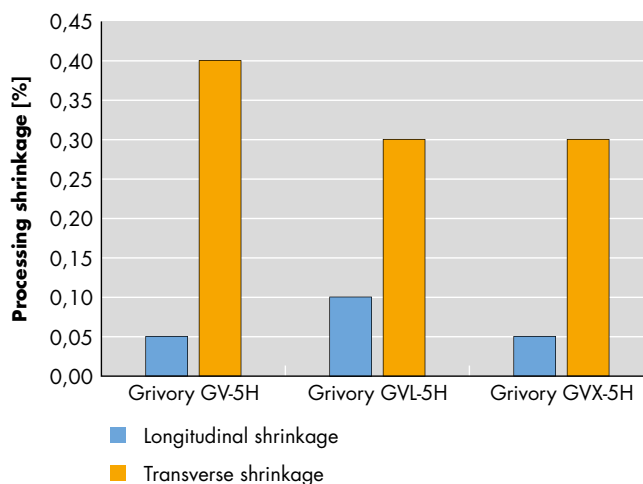

Shrinkage itself is dependent, among other things, on melt temperature, the holding phase, pressure loss in the cavity and the mould temperature.



**Stress-strain curves LFT polyamides, 50% long glass fibre reinforcement**

Grivory HT1VL-50

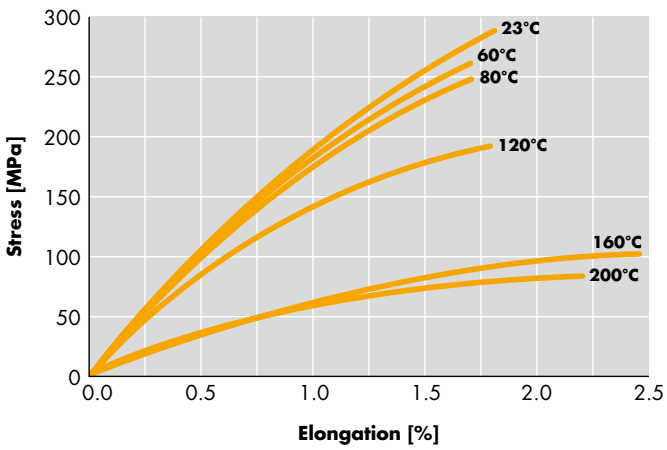

Grivory GVL-5H

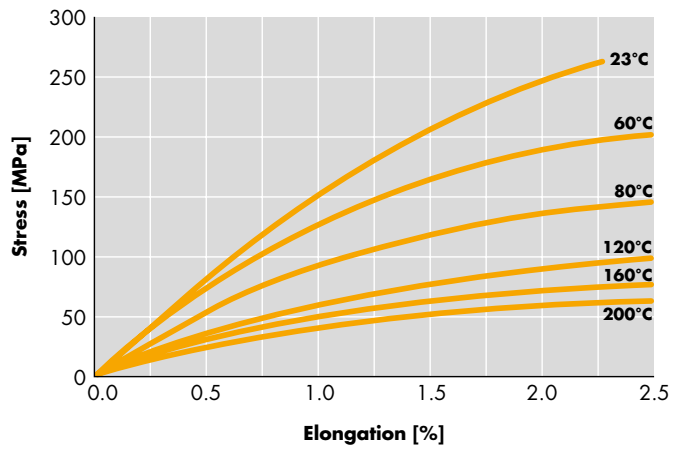

Grilon TSGL-50/4

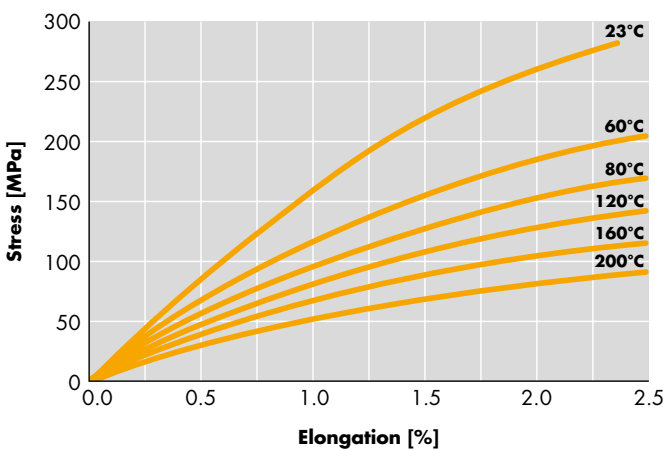

Grilamid LVL-5H

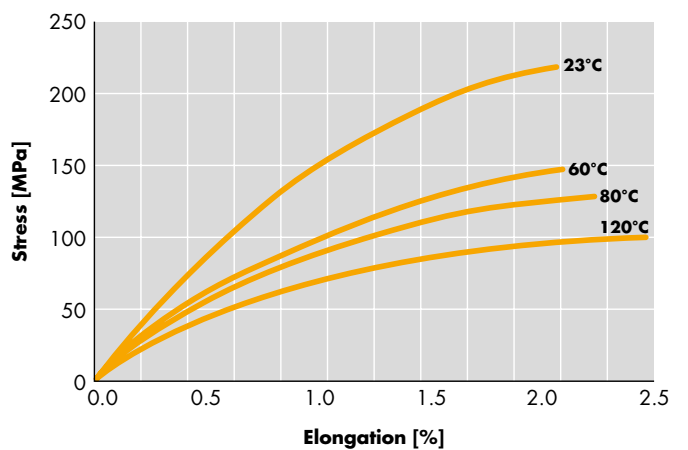

## ■ Design data – Short-term behaviour

# 20



### Tensile modulus LFT polyamides, 50% long glass fibre reinforcement

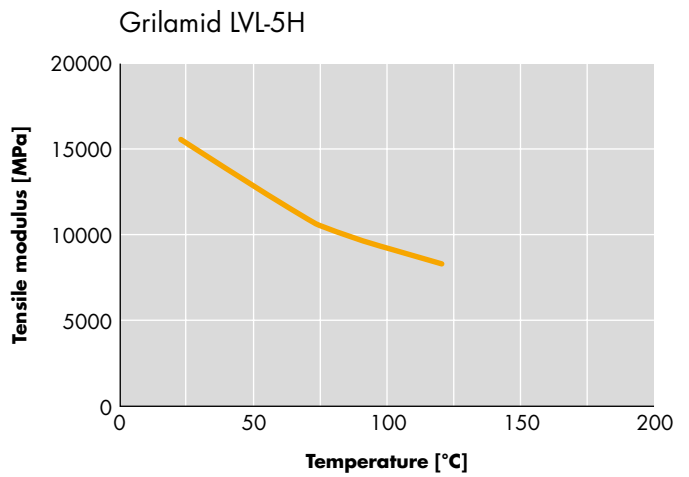
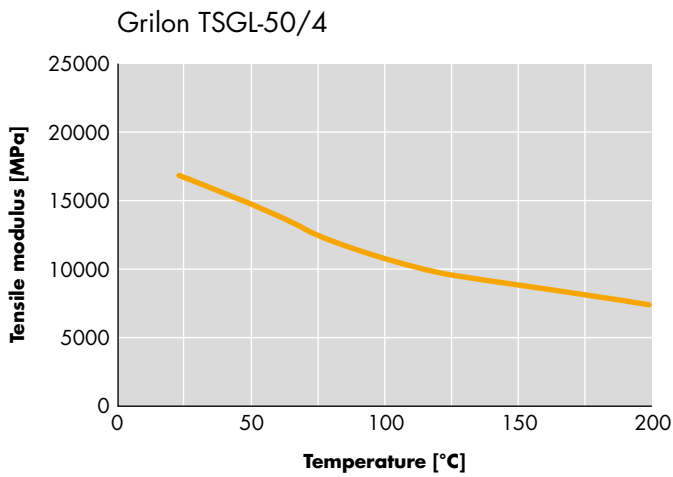
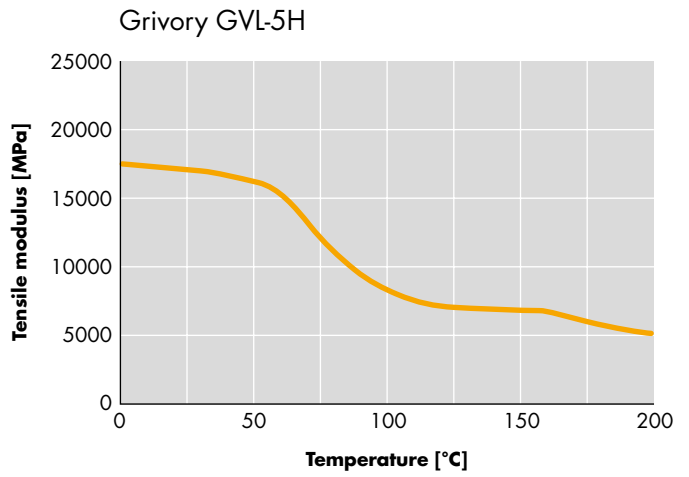
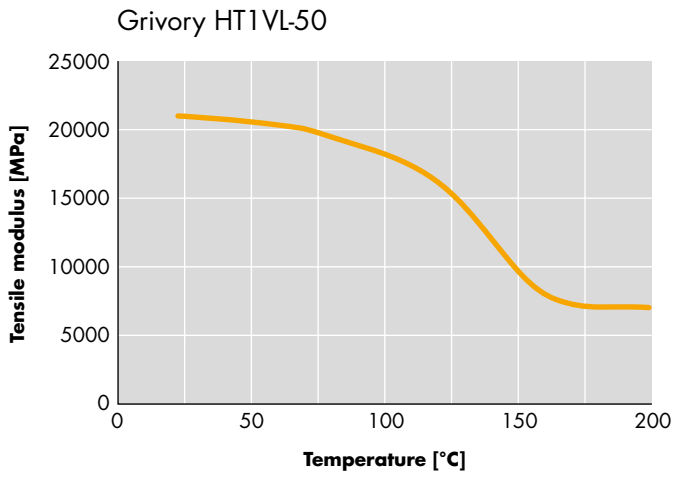



Creep curves LFT polyamides, 50% long glass fibre reinforcement (conditioned)

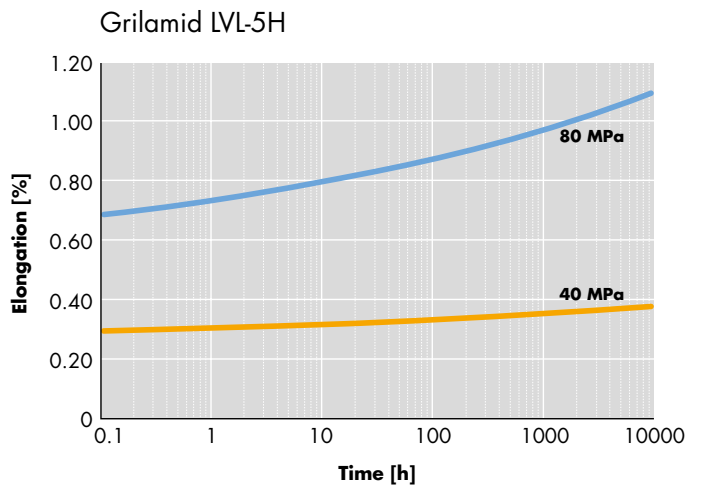
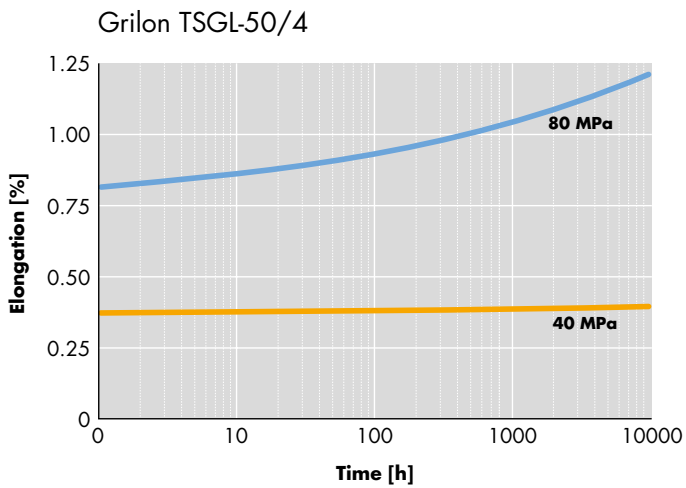
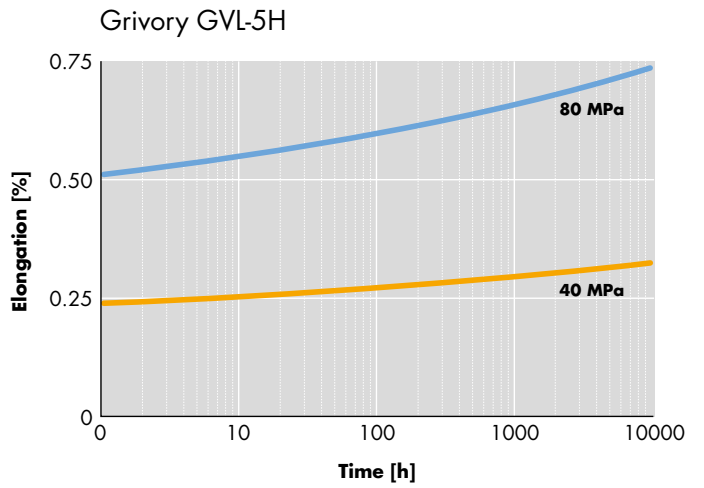
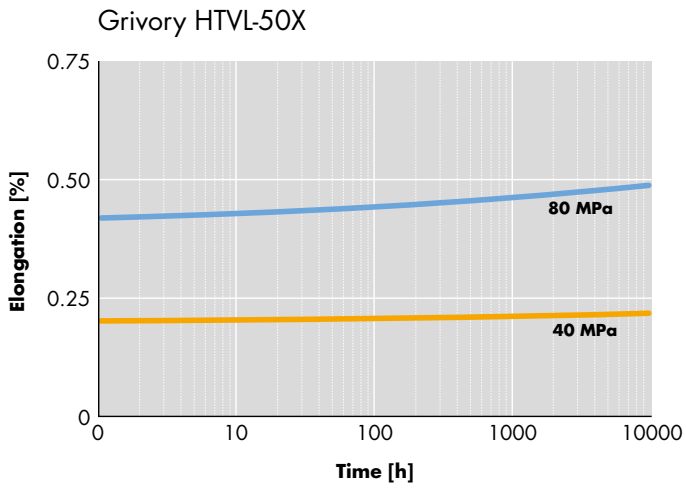

■ **Design data – Long-term behaviour**



**Flexural fatigue strength (Wöhler curves) LFT polyamides, 50% long glass fibre reinforcement (cond.)**

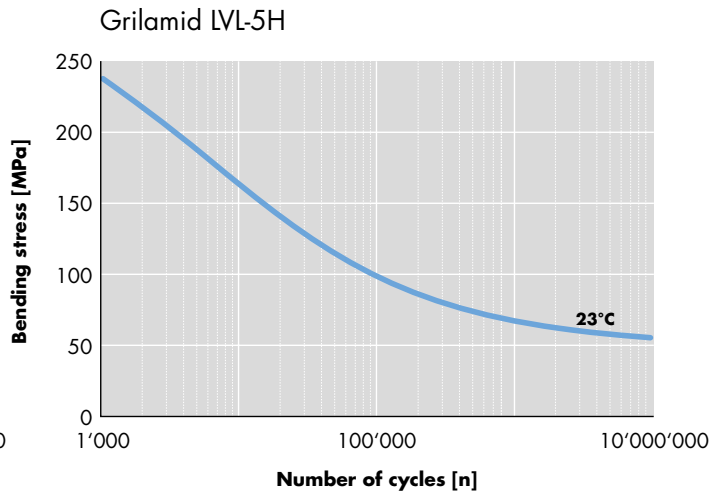
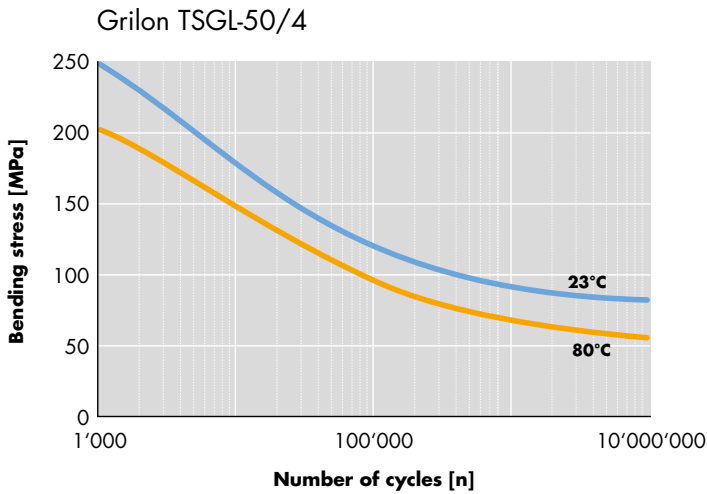
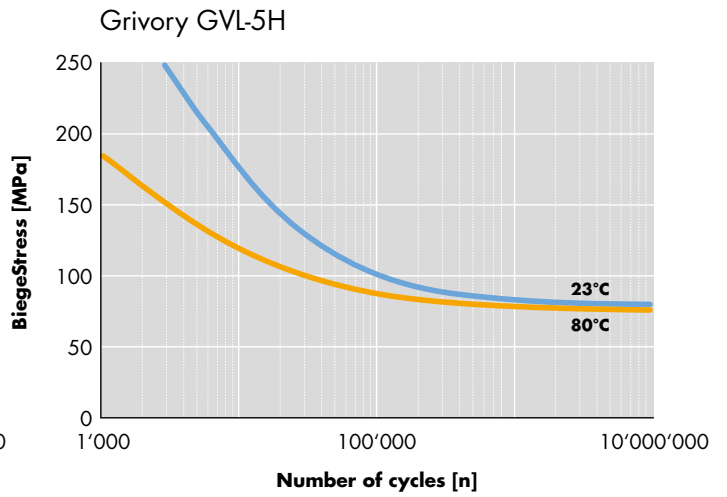
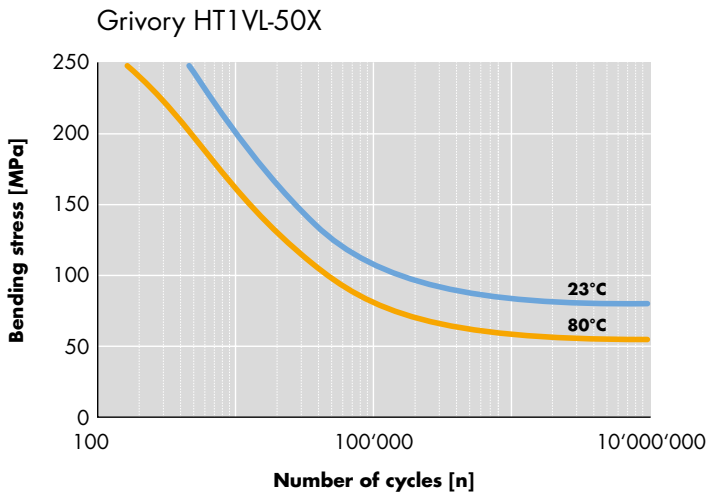



## Heat ageing

Long fibre reinforced products show excellent resistance to long-term heat ageing. The fibre structure, which determines decisively the thermo-mechanical properties, is not affected by ageing of the matrix polymer. This means that the excellent property values remain practically unchanged even after many hours of use in hot air. Naturally, a range of specifically stabilised products supplements the basic grades.

Heat ageing of LFT polyamides

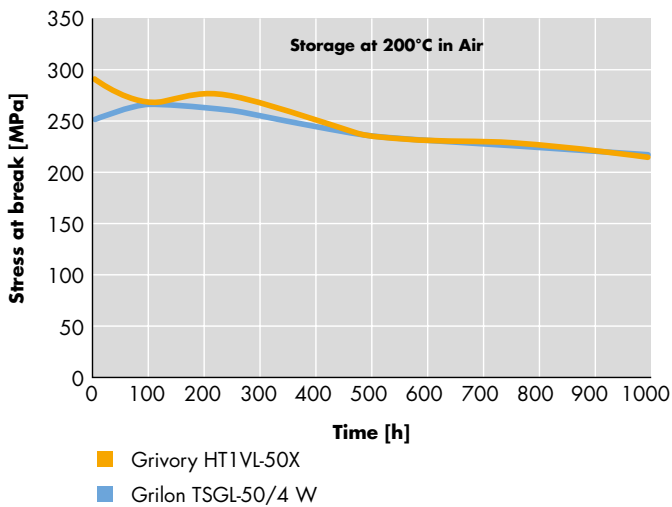

## Products reinforced with long carbon fibres

Due to the higher mechanical differences between carbon fibres and polymers and the difficult chemical inter-linking of these fibres to thermoplastic materials, the property advantages of long fibre reinforced polyamides are even more pronounced. Even with a low amount of fibre reinforcement, very high thermo-mechanical property values are achieved and form the basis for a whole series of light-weight construction components for sports articles or also in automotive construction.

Properties of carbon-fibre reinforced polyamides

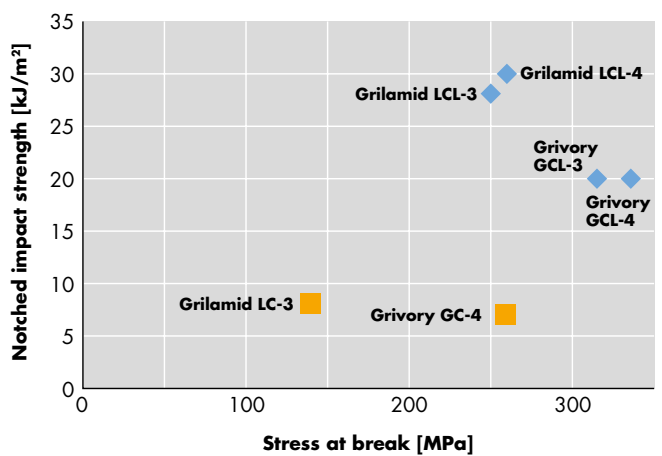

Properties of carbon-fibre reinforced polyamides

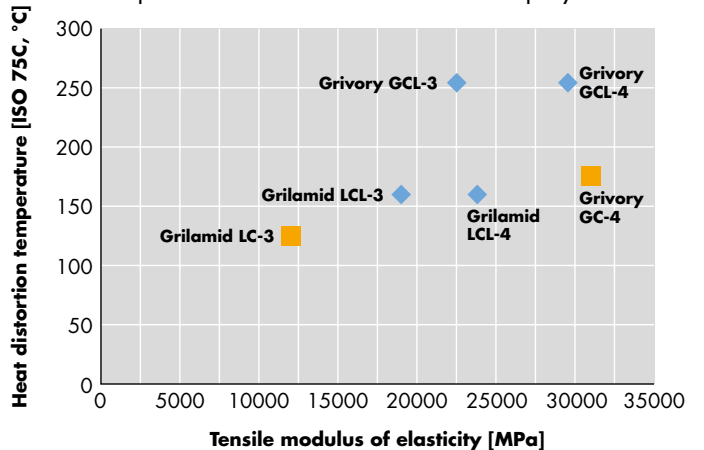

## ■ Products reinforced with long carbon fibres



The interlinked fibre structure also causes a significant increase in strength, stiffness, notched impact strength and heat distortion temperature of long carbon fibre reinforced polyamides. This effect is also achieved with products having a density of only 1.15 g/cm<sup>3</sup> (LCL-3H) to 1.34 g/cm<sup>3</sup> (GCL-4H). The advantage of larger elastic reversible deformation behaviour is maintained, and the tensile modulus shows a lower drop with increasing deformation or temperature.

Wöhler curve Grivory GCL-4H

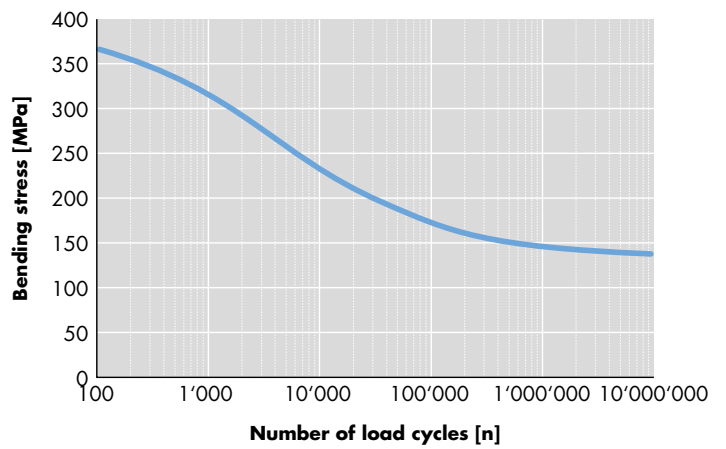

Stress-strain diagrams Grivory GCL-3H

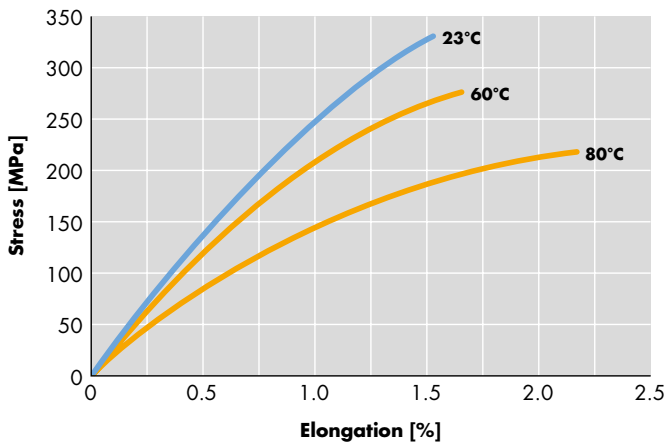

Tensile modulus Grivory GCL-3H

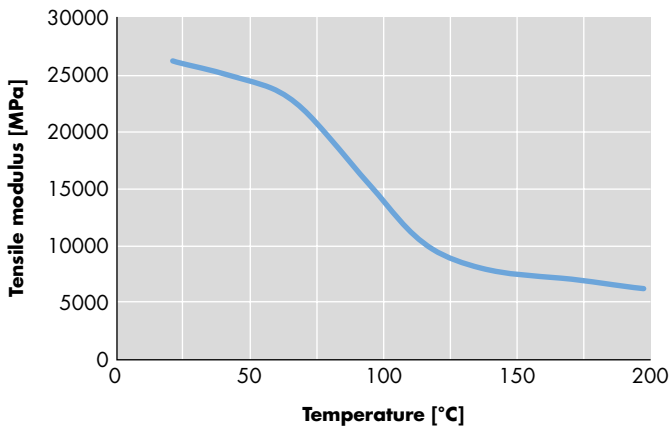





### Hybrid-reinforced LFT products

EMS-GRIVORY has developed a series of hybrid-reinforced LFT polyamides. These products are reinforced with two different kinds of long fibres: along with glass fibres, these products also contain carbon fibres as an additional functional material.

On the one hand, this creates products which have highest strength and stiffness values with lower density, suitable for lightweight applications. On the other hand,

these products can be used as structural materials made electro-statically conductible without loss of mechanical property values. Surface resistivity is less than 1 Mega-Ohm and allows use of lightweight polymer materials in explosion-protected environments (mining, chemical industry).

		GRILON		GRIVORY			
		<b>FE 6312 TSXL-40/4 DB black 9833</b>	<b>FE 6314 TSXL-50/4 DB black 9833</b>	<b>XE 5103 GXL-40H DB black 9915</b>	<b>FE 6341 GXL-40H DB V0 black 9915</b>	<b>FE6305 GXL-45H DB black 9915</b>	<b>FE 16108 GXL-50H DB black 9915</b>
Tensile modulus	dry	14000	17500	22500	16500	24000	19500
	cond.	10500	13500	20500	14500	21500	18500
Stress at break	dry	225	240	285	195	280	255
	cond.	165	185	230	165	230	220
Elongation at break	dry	2.0	2.0	1.7	1.7	1.7	1.8
	cond.	2.4	2.4	1.7	1.8	1.7	1.8
Impact strength 23°C	dry	55	80	60	55	70	70
	cond.	60	75	60	60	70	70
Notched impact strength 23°C	dry	20	30	18	18	20	25
	cond.	25	30	20	18	20	25
Melting temperature	dry	260	260	260	260	260	260
HDT C 8 MPa	dry	225	235	225	225	235	230
Volume resistivity	cond.	< 10 <sup>8</sup>	< 10 <sup>7</sup>	< 10 <sup>3</sup>	< 10 <sup>8</sup>	< 10 <sup>3</sup>	< 10 <sup>8</sup>
Surface resistivity	cond.	< 10 <sup>9</sup>	< 10 <sup>8</sup>	< 10 <sup>3</sup>	< 10 <sup>8</sup>	< 10 <sup>3</sup>	< 10 <sup>8</sup>
Density	dry	1.45	1.53	1.40	1.48	1.41	1.55
Flammability 1,6 mm	dry	HB	HB	HB	V0	HB	HB

## ■ Resistance to chemicals



### Resistance to chemicals

The LFT polyamides are chemically identical to standard grades. In general, LFT products are resistant to a large number of organic solvents and alkalis. Fuels, oils and greases have practically no effect on these products. Exposure to concentrated acids, especially at high temperatures, may cause hydrolytic decomposition. Diluted organic acids, on the other hand, do not damage LFT

products during short-term contact. Concentrated mineral acids, phenols, methanolic calcium chloride solutions and halogenated acetic acid may dissolve polyamides. Glycols and alcohols may attack the materials after long-term exposure at high temperatures.

Media	Resistance				
	Grilon	Grilamid	Grilamid TR	Grivory GV	Grivory HT
Acetic acid	●●●	●●●	●●●	●●●	●●●
Acetone	●●●	●●●	●	●●	●●●
Aluminium salts	●●●	●●●	●●●	●●●	●●●
Ammoniac	●●●	●●●	●●●	●●●	●●●
Aniline	●●	●●	○	●●	●●
Antifreeze	●●●	●●●	●●●	●●●	●●●
Benzene	●●●	●●●	●●●	●●●	●●●
Benzyl alcohol	●	●	●	●	●
Bromide	●	●		●	●
Butane	●●●	●●●	●●●	●●●	●●●
Butanol	●●●	●●●	○	●●	●●●
Calcium chloride sat.	●●●	●●●	●●●	●●●	●●●
Carbon tetrachloride	●●●	●●	●●●	●●●	●●●
Caustic potash 50%	●●●	●●●	●●●	●●●	●●●
Chlorine	○	○	○	○	○
Chlorobenzene	●●●	●	●●	●●●	●●●
Chloroform	●	●	●	●	●
Citric acid	●●	●●	●●●	●●	●●
Copper sulphate	●●●	●●●	●●●	●●●	●●●
Cresol	○	○	○	○	○
Crude oil	●●●	●●●	●●●	●●●	●●●
Diesel	●●●	●●●	●●●	●●●	●●●
Diethyl ether	●●●	●●●	●●●	●●●	●●●
Engine oil	●●●	●●●	●●●	●●●	●●●
Ethanol	●●●	●●●	○	●●●	●●●
Ethylene oxide	●●●	●●●	●●●	●●●	●●●
Fats	●●●	●●●	●●●	●●●	●●●



Media	Resistance				
	Grilon	Grilamid	Grilamid TR	Grivory GV	Grivory HT
Fluorine	●●●	●●●	●●●	●●●	●●●
Formaldehyde	●	●●	●●	●	●●
Formic acid	○	●	○	○	○
Freon liquid F12	●●●	●●●	●●●	●●●	●●●
Freon liquid F22	●	●	●	●	●
Glycerine	●●●	●●●	●●●	●●●	●●●
Heptane	●●●	●●●	●●●	●●●	●●●
Hydraulic oil	●●●	●●●	●●●	●●●	●●●
Hydrochloric acid 1%	●	●●	●●●	●	●●
Hydrochloric acid 10%	○	●	●●	○	●
Hydrogen peroxide 20%	●●●	●●●	●●●	●●●	●●●
Hydrogen sulphide	●●●	●●●	●●●	●●●	●●●
Iodine tincture alcoholic	○	○	○	○	○
Isooctane	●●●	●●●	●●●	●●●	●●●
Kerosene	●●●	●●●	●●●	●●●	●●●
Lactic acid	●	●●	●●	●	●
Magnesium chloride sat.	●●●	●●●	●●●	●●●	●●●
Methane	●●●	●●●	●●●	●●●	●●●
Methanol	●●●	●●	○	●●	●●●
Mineral oil	●●●	●●●	●●●	●●●	●●●
Nitric acid	○	○	●	○	○
Nitrobenzene	●●	●●	●●	●●	●●
Oleum	○	○	○	○	○
Oxalic acid	●●	●●●	●●●	●●	●●
Ozone	●	●	●	●	●
Perchlorethylene	●●●	●●●	●●●	●●●	●●●
Petrol	●●●	●●●	●●●	●●●	●●●
Petroleum ether	●●●	●●●	●●●	●●●	●●●
Phenole	●	●	●	●	●
Potassium carbonate sat.	○	○	○	○	○
Potassium permang. 5%	●●●	●●●	●●	●●●	●●●
Propane	●●●	●●	○	●●●	●●●
Salicylic acid	●●●	●●●	●●●	●●●	●●●
Sea water	●●●	●●●	●●●	●●●	●●●
Silicon oil	●●●	●●●	●●●	●●●	●●●
Soap solution	●●●	●●●	●●●	●●●	●●●

## ■ Resistance to chemicals

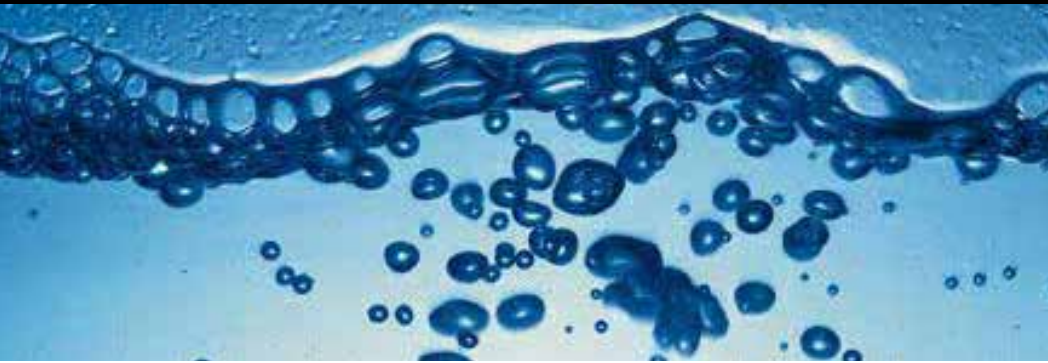

Media	Resistance				
	Grilon	Grilamid	Grilamid TR	Grivory GV	Grivory HT
Sodium chloride sat.	●●●	●●●	●●●	●●●	●●●
Sodium sulphate sat.	●●●	●●●	●●●	●●●	●●●
Styrene	●●●	●●●	●●●	●●●	●●●
Sulphur	●●●	●●●	●●●	●●●	●●●
Sulphuric acid 10%	●	●●	●●	●	●
Sulphuric acid, conc.	●	●●	●●	●	●
Tartaric acid	●●●	●●●	●●●	●●●	●●●
Terpentine	●●●	●●●	●●●	●●●	●●●
Tetralin	●●●	●●●	●●●	●●●	●●●
Toluol	●●●	●●●	●●●	●●●	●●●
Transformer oil	●●●	●●●	●●●	●●●	●●●
Trichlorethane	●●●	●●●	●●●	●●●	●●●
Trichlorethylene	●●	●●	●●	●●	●●
Urea	●●●	●●●	●●●	●●●	●●●
Uric acid	●●●	●●●	●●●	●●●	●●●
Vinegar	●●	●●●	●●●	●●	●●●
Water (23°C)	●●●	●●●	●●●	●●●	●●●
Xylole	●●●	●●●	●●●	●●●	●●●
Zinc chloride	●●●	●●●	●●●	●●●	●●●

●●●	resistant; no or only slight, reversible changes in weight and dimension, e.g. for Grilon in aqueous and alcoholic media, no damage.
●●	limited resistance; appreciable changes in dimension and possible irreversible changes in property values occur after longer periods of exposure. Consultation advisable before use.
●	not resistant - may be used under certain conditions (short exposure time)
○	soluble or already strongly attacked after only a short exposure time.



### Flame resistant standard products

All LFT products from EMS-GRIVORY fulfil requirements according to FMVSS 302 from wall thicknesses of 1 mm. The following products are listed in the flammability class UL 94 HB under the reference number EMS-CHEMIE E 53898 :

- Grivory GVL-5H
- Grilon TSGL-50/4
- Grilon TSGL-40/4

### Flame retardant, self-extinguishing products

The flame-retardant, long fibre reinforced products contain no halogens or red phosphorous. They are self-extinguishing and correspond to the classification UL 94 V-0 and 5VA. The "Yellow Cards" show the properties listed by UL and can be found under the reference number EMS-CHEMIE E 53898:

- Grivory XE 5106 / Grivory GVL-4H V0 / 5VA
- Grivory XE 5107 / Grivory GVL-5H V0 / 5VA

### RoHS:

All flame retardant LFT polyamides from EMS-GRIVORY satisfy the RoHS requirements (2002/95/EG and 2011/65/EU, Restriction of Hazardous Substances)

### WEEE:

Parts manufactured from flame-retardant LFT polyamides made by EMS-GRIVORY are exempt from requirements concerning "selective recycling" according to the 2002/96/EC governing recycling of electrical and old appliances.

### FMVSS:

All LFT products from EMS-GRIVORY satisfy the requirements of FMVSS 302 (ISO 3795, DIN 75200) from wall thicknesses of 1 mm. Burning rates determined in plate flaming tests are substantially lower than the standard requirements 100 mm/min at around 20 – 30 mm/min.

### Drying and storage

All LFT polyamides are delivered dried and ready for use in air-tight bags. (Bag size 25 kg, octabins with 1000kg). Pre-drying is not necessary if the material is handled and stored correctly. Sealed and undamaged containers, in particular bags, can be stored for years if sheltered from the weather. A dry room where bags are protected from damage is recommended as storage space. At cold storage temperatures it is recommended that material is stored for around one day at processing temperature to prevent condensation forming on the surface of the pellets when the bags are opened. Damaged bags should be resealed as soon as possible or the material transferred to air-tight containers.

If further drying becomes necessary due to damaged packaging or to the material being stored in contact with the air for too long, this should be carried out using dry-air oven or vacuum system. Circulating air ovens are not recommended as they tend to cause moistening of the pellets at a high ambient temperature and with high air humidity.

### Recommended drying conditions

Type of drier	Drying temperature	Drying time
Dessiccant	70 - 80°C	4 - 12 hours
Vacuum	max. 100°C	4 - 12 hours

The drying time is dependent to a great degree on the outset moisture content. In case of doubt, drying should be carried out for 8 to 12 hours. Drying temperatures above 80°C in desiccant dryers should be avoided in order to prevent yellowing of the pellets.

## ■ Processing - Injection moulding



### Injection moulding

Long fibre reinforced polyamides can be processed using conventional injection-moulding machines and need no specialised equipment.

A few general rules should be followed however, to ensure that the best possible result can be achieved during processing.

### Transport of pellets

Long-fibre pellets can be transported without problem using pneumatic transport systems. It should be noted that due to their length, the pellets are around three times heavier than conventional compounds. To prevent unnecessary damage to transport systems, the vacuum pressure should be adjusted so that the pellets are transported efficiently but are not accelerated to high speeds. Feed hopper necks should be designed at an angle and not directly head-on. Feed lines and pipes with a diameter of 50 mm have proven suitable.

### Screw geometry

Long fibre reinforced polyamides from EMS-GRIVORY can be processed using standard screw designs. Screw diameters are today in the range from 20 mm up to 170 mm; most often, screws with a diameter of 30 to 90 mm are used. It is recommended that screws with an extended feed zone (approx. 60% of the total length) are used, which have been used for processing engineering plastics for many years now. The efficient screw length should be between 18 and 22 D. Short-compression screws, screws with degassing sections or mixing sections and shear elements must be avoided. Screws with a compression ratio of 2:1 to 2.5:1 have proved very suitable. Low-cut screws, especially in the area of the discharge zone may also increase the average length of the reinforcing fibres inside the component.

It is decisive that the pellets have a temperature above that of the melting point at the start of the compression zone as they themselves already have a very high heat distortion temperature.

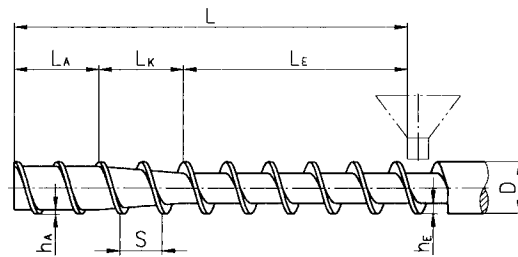

- $L_E$  = Feed zone (60%)
- $L_K$  = Compression zone (20%)
- $L_A$  = Discharge zone (20%)
- $s$  = Flight pitch 0.8 - 1.0 D
- $h$  = Flight depth (E = feed, A = discharge)
- $L$  = Screw length
- $D$  = Screw diameter

Heating through shear should be avoided as far as possible in order to exactly control the melt temperature and prevent local over-heating. The choice of screw diameter should correspond to the shot volume of the mould. Around 30 to 70% of the maximum metering stroke should be made use of.

A non-return valve is necessary to prevent the melt flowing back into the cylinder during mould filling and in the post-pressure phase. A ball retaining valve should not be used for processing of LFT polyamides.

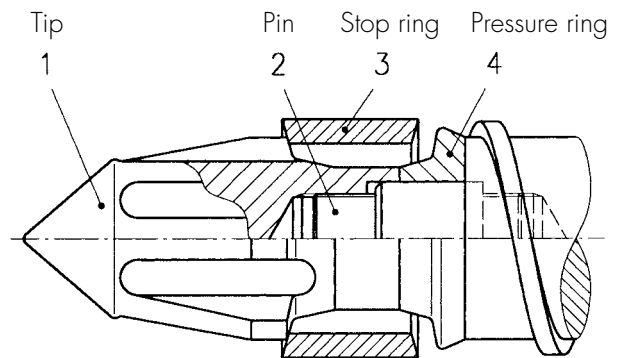



### Nozzle

As with all thermoplastic materials, an open nozzle with rounded internal contours should be used to prevent unnecessary shearing and deposits. The minimum diameter of the bore should be kept as short as possible to keep pressure loss low.

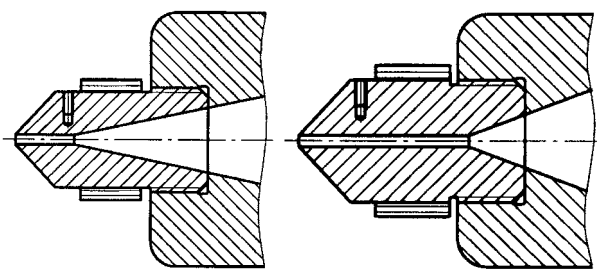

Free-flowing, open nozzle

Open nozzle with long bore to delay exit of the melt.  
Disadvantage: Higher flow resistance

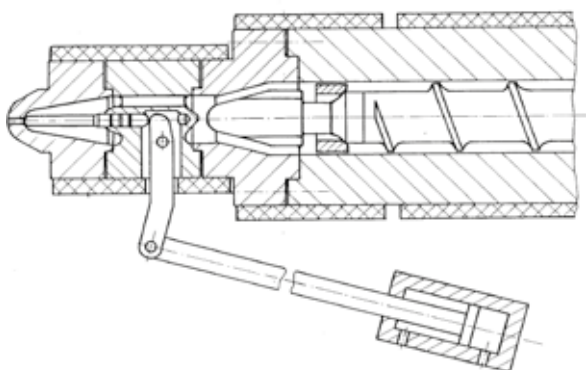

Example of a hydraulically controlled needle valve nozzle

Hydraulically controlled needle valve nozzles have also proved suitable in use. Spring-closing nozzles should be avoided as they cause high shear and allow only inadequate control of the post-pressure phase.

### Wear

Long fibre reinforced polyamides do not cause higher wear compared to conventional compounds as the number of abrasive fibre ends is significantly lower. It should be ensured that the grade of steel used for machinery and mould has sufficient resistance to corrosion as polyamides, like many performance polymers, may extract unprotected steel of carbon.

### Mould design

Moulds for use with long fibre reinforced polyamides follow the same rules as for standard materials. For calculation of the necessary clamping strength of injection moulding machines, a medium-range pressure of 800 bar is recommended.

### Runner and gate systems

In order to avoid high pressure loss, insufficient control of the post-pressure phase and damage to the fibres, we recommend use of as large runner cross-sections as possible.

The simplest way is to use a direct sprue gate, as near as possible to the maximum wall thickness of the shaped part. Tunnel and film gates are also suitable and often used. The following dimensions are recommended:

- Runner:  $> 1.4 \times$  max. wall thickness of shaped part
- Gate diameter:  $> 0.8 \times$  max. wall thickness of shaped part
- Minimum tunnel gate for LFT: 1.5 mm

3-plate moulds are not suitable for processing of LFT polyamides as a wide enough tunnel cross-section of the runner has such high strength, that as a rule, the part remains blocked in the cavity.

## ■ Mould design



### Hot runner systems

Hot runner systems are excellently suited for processing of long fibre reinforced polyamides. Open, externally heated systems should be used where the nozzle tip temperature can be closely and accurately controlled and overall, an even temperature distribution can be achieved without local heat loss.

Piston valve systems have shown to be more reliable than needle valve nozzles and subject the melt to significantly less shear. The hot runner should only maintain the mass temperature in the cylinder without further heating the melt itself. This determines the following recommended temperature ranges for hot runner systems:

- Grilamid LVL/LCL: 270 - 290°C
- Grivory GVL/GCL: 290 - 305°C
- Grivory HTVL: 335 - 345°C
- Grilon TSGL: 285 - 305°C

### 6 Golden Rules for positioning the gating for LFT polyamides

1. If possible, a direct sprue gate on the part should be used
2. The gate should be positioned near the maximum wall thickness of the part
3. The gate should not be located in the areas of maximum stress of the part
4. A cold slug collector should always be used in order to catch cold material from the machine nozzle
5. The wall thickness of the runner must be significantly higher than the maximum thickness of the shaped part.
6. Formation of a free jet of material at the gating should be avoided.

### Draft angle

Draft angles should always be calculated generously and help to achieve short cycle times. The deeper the surface structure chosen, the larger the minimum draft angle required. The larger the draft angle, the lower the necessary ejection forces.

$$\left( B = \frac{F_{KH}}{F_{ZH}} \right) \text{ Ratio of demoulding forces from conical sleeve to cylinder}$$

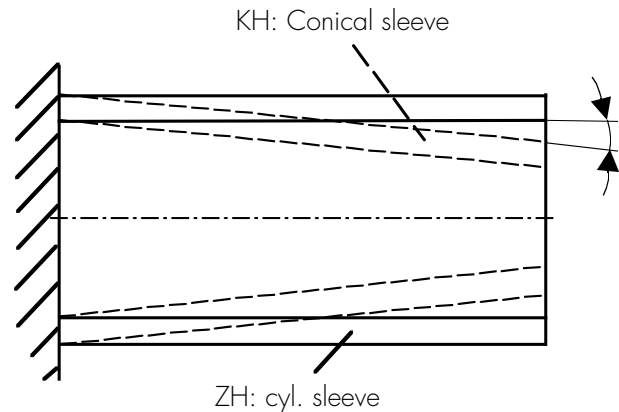



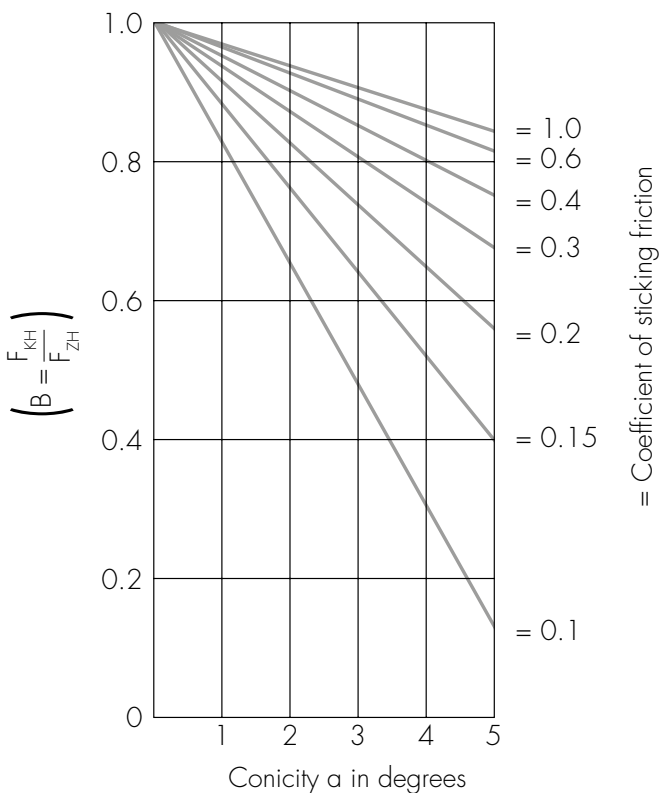

Recommended draft angles for different surface structures:

Mould surface	Erosion testing standard VDI 3400 class	Depth of roughness mm		Draft angle
		$R_{max}$	$R_a$	
Blasted	18	5.0	0.85	1°
	21	8.3	1.12	
Fine erosion	24	12.0	1.60	2°
Medium erosion	27	19.0	2.50	
	30	26.5	3.20	3°
33	39.0	4.50		
Coarse erosion	36	53.0	6.30	5°
	39	70.0	9.00	

$R_{max}$  = max. depth of roughness  
 $R_a$  = average depth of roughness

### Ventilation

Ventilation must be ensured during the mould filling process to allow air in the mould cavity to escape. Insufficient ventilation may lead to too high filling pressure, local burning spots on the polymer and poor weld lines. With an increase in temperature, longer cooling times may even become necessary.

Ventilation can be ensured through ejection pins with and without function or thin slits in the mould parting surfaces. Long fibre reinforced polyamides tend to exhibit less flashing as the impregnated fibres retain the polymers.

Ejection pins are designed with H7/G6 clearances, ventilation slits in the parting surfaces may be up to 0.15 mm high. These degassing openings should be thin for a relatively short distance (1.5 to 2.5 mm) and then have a generous cross-section.

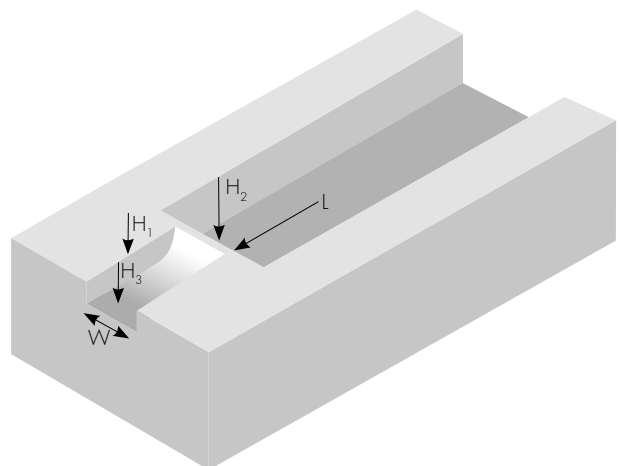

$H_1 - H_2 = 0.01$  to  $0.02$  mm,  $H_1 - H_3 = 1 - 3$  mm,  
 $L = 0.8 - 1.5$  mm,  $W = 2 - 5$  mm

## ■ Processing parameters

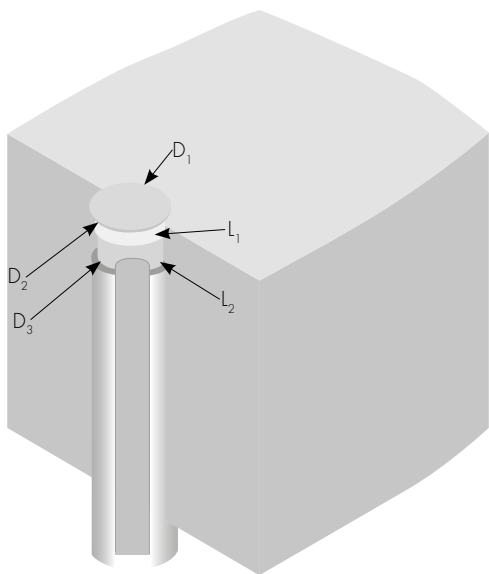
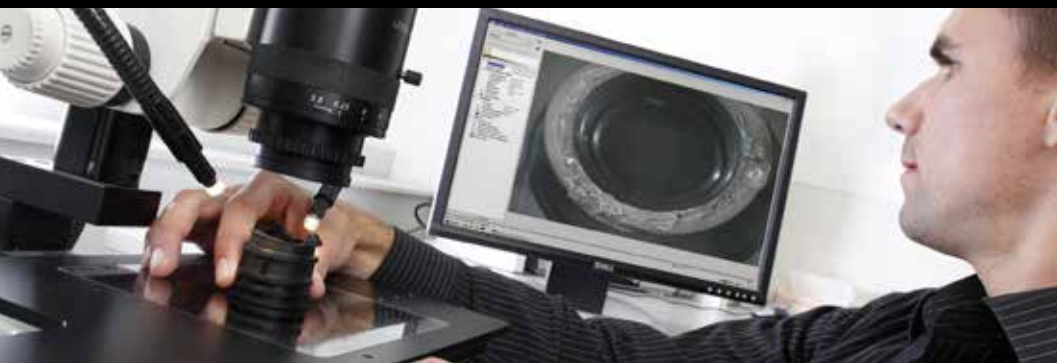

$D_1 - D_2 = 0.01 - 0.02 \text{ mm}$ ,  $D_2 - D_3 = 1 - 2 \text{ mm}$ ,  
 $L_1 = 2 - 4 \text{ mm}$ ,  $L_2 = 3 - 5 \text{ mm}$

### Mould cooling

Mould cooling systems suitable for processing of LFT polyamides must correspond to the same rules as for standard polyamides. Possible ejection temperatures are around 10 to 20°C higher as LFT components have higher heat distortion temperatures.

### Melt temperature

The melt temperature is dependent not only on the selected cylinder temperature, but also on other process parameters such as:

- screw speed (revolutions)
- back pressure
- dwell time
- melt viscosity
- clearance between screw and cylinder and in the non-return valve
- high shear in gate / sprue

It should be generally avoided increasing the melt temperature in an uncontrolled manner due to too high screw speed, high pressure or too rapid injection. Long fibre reinforced polyamides from EMS-GRIVORY have excellent temperature stability and should be processed at high temperatures. This lowers filling pressures and inherent stresses, shear is reduced and in this way, the fibres suffer less damage. As long fibre reinforced polyamides have significantly higher thermo-mechanical properties, it must be ensured that the pellets are above melt temperature when they enter the compression zone. In particular, when using larger dosing volumes larger than the screw diameter it is recommended that a flat or even declining temperature profile is used. The hopper flange should not be cooled excessively, but should be about the same temperature as the drier (approx. 80°C) in order not to waste energy.

Recommended mould temperatures when processing LFT polyamides are the same as for standard polyamides.

The following basic machine settings are recommended for processing LFT polyamides with 50% glass-fibre reinforcement:

Grivory GVL	Dosage volume (to screw diameter)		
	$\leq 1 \text{ d}$	1 - 2 d	$\geq 2 \text{ d}$
Hopper flange	80°C - 100°C	80°C - 100°C	80°C - 100°C
Feed zone	290°C	300°C	310°C
Compression zone	300°C	300°C	305°C
Discharge zone	310°C	300°C	300°C
Nozzle	300°C	300°C	300°C
Mould temp.	80°C - 120°C	80°C - 120°C	80°C - 120°C
Melt temp.	290°C - 310°C	290°C - 310°C	290°C - 310°C



Grivory HT1VL	Dosage volume (to screw diameter)		
	<= 1 d	1 - 2 d	>= 2 d
Hopper flange	80°C - 120°C	80°C - 120°C	80°C - 120°C
Feed zone	340°C	345°C	350°C
Compression zone	345°C	345°C	350°C
Discharge zone	350°C	345°C	345°C
Nozzle	340°C	340°C	340°C
Mould	140°C - 170°C	140°C - 170°C	140°C - 170°C
Melt	340°C - 350°C	340°C - 350°C	340°C - 350°C

Grivory LVL	Dosage volume (to screw diameter)		
	<= 1 d	1 - 2 d	>= 2 d
Hopper flange	80°C - 100°C	80°C - 100°C	80°C - 100°C
Feed zone	270°C	280°C	290°C
Compression zone	280°C	280°C	285°C
Discharge zone	285°C	280°C	280°C
Nozzle	280°C	280°C	280°C
Mould	60°C - 120°C	60°C - 120°C	60°C - 120°C
Melt	280°C - 290°C	280°C - 290°C	280°C - 290°C

Grivory TSGL	Dosage volume (to screw diameter)		
	<= 1 d	1 - 2 d	>= 2 d
Hopper flange	80°C - 100°C	80°C - 100°C	80°C - 100°C
Feed zone	290°C	300°C	310°C
Compression zone	300°C	300°C	305°C
Discharge zone	310°C	300°C	300°C
Nozzle	300°C	300°C	300°C
Mould	80°C - 120°C	80°C - 120°C	80°C - 120°C
Melt	290°C - 310°C	290°C - 310°C	290°C - 310°C

Products containing larger quantities of fibre reinforcement should be correspondingly processed at temperatures around 5 to 10°C higher, with less reinforcement, at temperatures 5 to 10°C lower (cylinder and melt temperature); mould temperatures do not change.

### Plasticising

Preferably, low screw speeds (revolutions) and back pressures should be used for dosage and melting of LFT polyamides. Make use of the whole cooling time for dosage and reduce the back pressure as far as possible. The screw should, however, be pushed back by the melt without jerking.

### Mould filling and post-pressure

The mould should be filled carefully to avoid shear heating of the melt and unnecessary breakage of the fibres. The mould filling time depends greatly on the part to be made and can vary from anywhere between 0.5 seconds (small component, a few grams heavy) up to nearly 10 seconds (15 kg shot weight). Mold Flow Analysis can help to determine the optimum filling time. The switch-over to post-pressure should not take place until static filling of the cavity is complete (component is 95% filled without post-pressure). The time and amount of post-pressure applied should be adjusted by determination of the sealing point. The switch-over point, amount and duration of post-pressure are decisive for consistent component weight and, therefore, for the component properties.

### Cooling time

The post-pressure and cooling period take up the largest part of the whole cycle time. While the post-pressure ensures a consistent component weight, the cooling time ensures the most important component dimensions and no damage during demoulding. In general, long fibre reinforced polyamides can be processed rapidly and demoulding can take place at high temperatures. The following formula can be taken as rule of thumb:  
 Total cooling time = (1.5 to 2) x (wall thickness in mm)<sup>2</sup>  
 [in seconds]

## ■ Processing - Post-treatment



### Golden rules for the processing of long fibre reinforced polyamides

1. Make sure that the pellets are at least at melt temperature at the start of the compression zone.
2. Use a flat or declining temperature profile if the dosage volume is larger than the screw diameter.
3. Work generally at the high end of the recommended temperature range (especially with long flow paths) in order to avoid unnecessary shear from early solidification of the edge layers.
4. Compared to standard polyamides, wear and abrasion is relatively low if the products are processed at sufficiently high temperatures, as the number of fibre ends is smaller.
5. Mould temperatures should be kept in the higher range in order to improve surface quality and to achieve lower filling pressures. As a rule, this does not have an influence on the cycle time.
6. The gate system should be positioned near the maximum wall thickness of the part to avoid sink marks, but not in the areas of maximum component stress.
7. Use sufficiently large gate and sprue cross-sections in order to avoid unnecessary shear and to allow the post-pressure phase to be controlled well.
8. The mould should be filled slowly to avoid heating from friction.
9. The mould cavity should have sufficient ventilation.
10. Optimise the post-pressure phase (pressure and time) in order to achieve consistent component weights.

Further information is given in the processing brochure for LFT polyamides from EMS-CHEMIE AG.

### Post-treatment

Long fibre reinforced polyamides can be given the same kinds of post-treatment as standard products. The recommendations for each individual product family should be followed.

### Bonding

Due to their basic chemistry, polyamides can be relatively easily bonded using a range of adhesives. The partially aromatic Grivory grades as well as the polyamide 12 products, which have very good resistance to chemicals, may require further methods of pre-treatment if very high bonding strength is required.

General notes / pre-treatment	<ul style="list-style-type: none"> <li>• Surfaces to be bonded should be clean, dry and degreased</li> <li>• Demoulding media (sprays or powder) should not be used during processing</li> <li>• Pre-treatment: Grinding / brushing / sand-blasting / corona discharge / plasma pre-treatment</li> <li>• Flaming</li> <li>• Application of a primer</li> </ul>
Adhesives	<ul style="list-style-type: none"> <li>• Grilon / Grivory / Grilamid: Single-component adhesives such as cyanacrylate, methacrylate</li> <li>• Two-component adhesives such as polyurethane, epoxy resins</li> <li>• Grilamid: Hot melt adhesives</li> </ul>

The choice of a suitable adhesive system is dependent to a great extent on the component, the bond line geometry and the requirements on the bond (strength, temperature, moisture in the environment). Please contact the application development centre at Domat/Ems for more information about suitable bonding systems.



**Welding**

All welding methods used for thermoplastic reinforced materials are also suitable for use with long fibre reinforced polyamides.

General notes / pre-treatment	<ul style="list-style-type: none"> <li>• Areas to be welded must be clean, dry and degreased.</li> <li>• Demoulding media (sprays or powder) should not be used during processing.</li> </ul>
Welding methods	<ul style="list-style-type: none"> <li>• Grilon / Grivory / Grilamid:</li> <li>• Heated element welding (large-area components)</li> <li>• Ultrasonic welding (small components)</li> <li>• Spin welding (round, smooth parts)</li> <li>• Vibration welding (smooth components)</li> <li>• Diode laser welding (complex parts)</li> </ul>

**Screw fastening**

General notes / pre-treatment	<ul style="list-style-type: none"> <li>• Not necessary, stud holes must be adjusted to suit the corresponding geometries</li> </ul>
Screw fastening / riveting / beading	<ul style="list-style-type: none"> <li>• Grilon / Grivory / Grilamid: Metal thread inserts can be easily embedded using ultrasonic welding. Riveting and beading can be carried out using ultrasound as well as heated moulding elements.</li> <li>• Self-tapping (thread forming) screws achieve very high strengths in LFT components. We recommend use of Delta PT screws from the EJOT company.</li> <li>• Direct threads in LFT components should be injection-moulded and not cut in order to ensure good fibre-reinforcement of the thread grooves.</li> </ul>

**Painting**

Due to their excellent resistance to chemicals and their hydrophilic character, Grilon and Grivory LFT products can be very successfully painted with one or two coats. As a rule, complex pre-treatment is not necessary. Improved paint adhesion can be achieved with suitable pre-treatment methods for Grilamid grades.

General notes / pre-treatment	<ul style="list-style-type: none"> <li>• Surfaces to be painted should be clean, dry and degreased.</li> <li>• Demoulding media (sprays or powder) should not be used during processing</li> <li>• For Grilamid grades, improved paint adhesion can be achieved using flaming, corona discharge or plasma treatment or through mechanical roughening of the surface.</li> </ul>
Paint systems	<ul style="list-style-type: none"> <li>• One and two-component polyurethane paints</li> <li>• No or only very small property changes through painting of LFT polyamides.</li> </ul>

## ■ Post-treatment

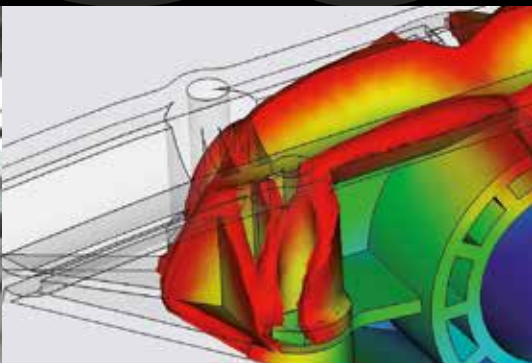

### Metal plating

All LFT polyamides can be successfully metal-plated using high-vacuum methods.

General notes / Pre-treatment	<ul style="list-style-type: none"> <li>• Surfaces to be metal-plated must be clean, dry and degreased.</li> <li>• Demoulding media (sprays or powder) should not be used during processing.</li> </ul>
Plating systems	<ul style="list-style-type: none"> <li>• Grilon / Grivory / Grilamid: High-vacuum, galvanic metal-plating with corresponding pre-treatment.</li> </ul>

### Machining

Normally, post-treatment involving machining of an injection-moulded part should be unnecessary. If it cannot be avoided however, we recommend the following cut settings:

	Method				
	Unit	Turning	Milling	Sawing	Drilling
Clearance angle	-	5-10	3-15	15-30	5-10
Rake angle	-	2-10	5-15	3-6	6-15
Cutting speed	m/min	200-400	300-800	200-500	50-120
Rate of feed	mm/U	0.1-0.5	0.1-0.5	-	0.1-0.5
Point angle	-	-	-	-	90-120
Circular pitch	mm	-	2-8	-	-

As LFT polyamides are generally very hard materials with a high amount of reinforcement, the use of diamond-tipped tools is recommended for mechanical machining.

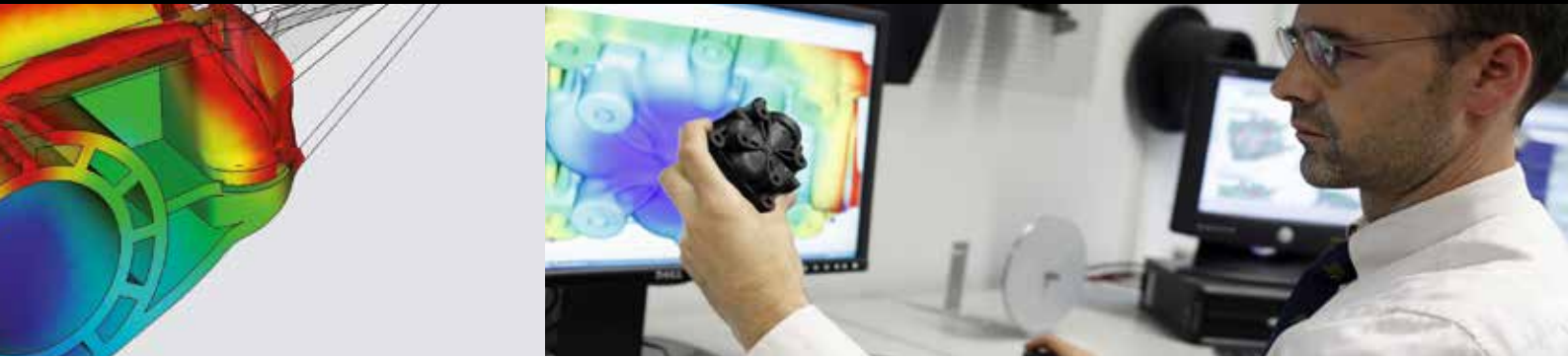

We offer advisory services and know-how to our customers, starting from development and continuing right through to serial manufacture of a part. Our customer services provide quality, reliability and technical support.

- We draw up and discuss with you a range of varied designs for your application in order to find an optimum solution from both a technical and economical point of view.
- As a material specialist, we provide you with a material recommendation that „fits“. To achieve this we compare and analyse possible materials, thereby ensuring that we recommend the material which is best suited to your application.
- We also provide support in identifying and carrying out tests suited to your application. Our modern test laboratories can offer a wide and varied range of mechanical, thermal, chemical and electrical tests.
- Are you experiencing problems with material sampling or the start of production? With our application engineering know-how, we can offer you expert advice for process and mould optimisation, and our technical customer services can also provide on-site support.

### CAE

Using computer-aided simulation calculation systems, the application development centre of EMS-GRIVORY is capable of providing customers with optimal mould design support. The CAE systems used allow the moulded parts to be designed using Finite Element (FE) programmes. The filling process is then described by rheological simulation.

An FE analysis provides information about mechanical loading and stresses on the moulded part. Based on this calculated stress distribution, specific modifications can be implemented and tested directly with a new FE calculation.

As soon as satisfactory structural properties have been achieved using FE analysis, rheological simulation can be used to evaluate the optimal sprue position and to provide qualitative statements about fibre alignment, shrinkage and warpage of the parts.

Through use of modern FE and rheological simulation tools, the EMS-GRIVORY team of experts is able to provide customers with optimal mould design support using virtual 3D data.

### Prototype moulds and Selective Laser Sintering (SLS)

Quick realisation and rapid implementation of a good idea is the key to success. With construction of prototype moulds, EMS-GRIVORY helps minimise the risk, save valuable time and reduce costs.

Prototypes of moulded parts can also be optimised through use of FE analysis and rheological simulation. The prototype moulds can then be used to manufacture a small series of moulded parts at minimum expense, thus allowing practical tests to be carried out before the serial production is started. This preparation work reduces outlay and helps avoid expensive modifications to manufacturing moulds.

## ■ Make use of our test laboratories



### **Material testing and quality control**

The Business Unit EMS-GRIVORY has state of the art equipped laboratories at its disposal in the material testing and quality control departments.

Our equipment infrastructure allows us not only to determine the conventional mechanical, thermal and electrical properties of our construction materials for data sheets and homologation, but also to carry out research and development work and to support application development work with practical tests.

- The mechanical testing laboratory is equipped with universal testing machines, impact testing apparatus (both automated and instrumented pendulum) as well as equipment to measure the creep behaviour of polymer materials in air and liquids.
- We also have pneumatic flexible bending test apparatus and dynamic mechanical test equipment to measure dynamic short and long-term stress behaviour of long fibre reinforced materials.
- The rheology laboratory of material testing is capable of providing key index material index figures necessary for simulation of injection-moulding processes.
- Tests to determine the resistance to chemicals, heat and weathering provide us with information about application possibilities for our materials under extreme conditions.
- Chemical and processing-technical tests allow us to check the quality of our products and to ensure consistent quality levels.

In addition, our materials testing department also has special equipment at its disposal such as the EMS P-Tester (determination of permeation behaviour of fuel system components), a fuel circulation unit (test of the life expectancy of polymer petrol lines under extreme conditions), a hot-air pressure threshold tester (testing of extrusion blow-moulding components under practical conditions) and many others.

With these services we offer our customers active support in the choice of material and material development as well as in component design and part testing.





The worldwide production sites of EMS-GRIVORY follow the rules of our common quality management system based on the international standards ISO9001:2008 and ISO/TS 16949:2009.

All production lines for LFT products are certified by the Swiss Association for Quality & Management Systems (SQS).

The regulations of ISO/TS 16949 are more far-reaching and stricter. Our management system is process-oriented towards the primary goal of customer satisfaction. Our efforts are concentrated on conformance with quality requirements and appropriate use of resources.

The quality planning cycle starts with market research and ends with customer services. Our quality system also includes research and manufacturing teams and extends right up to technical service during serial production.

Development projects are tackled by interdepartmental teams working according to processes of simultaneous engineering, where team members are not limited to thinking and acting solely within the categories of their own departments, but work towards a mutual objective. During this work, up-to-date technologies (such as statistical experimental design) and preventive methods (such as failure mode and effect analysis, FMEA) play a central role. The guiding principle of project management is to avoid faults before solving them!

Statistical process control is used to monitor and improve our manufacturing processes. The accuracy of our equipment is monitored in measurement system analyses.

Continuous improvement of our LFT products, services and productivity as well as adjustment of new products to suit market and customer requirements, is the core element of an official improvement programme to which all EMS employees are committed.



**Product families**

All LFT polyamides are based on the product families manufactured by EMS-GRIVORY, successful in the market for many years. These are:

**Grivory HT**

Enhanced performance at high temperature

Grivory® is the trade name for a group of engineering polymers. Grivory HT, manufactured and sold by EMS-GRIVORY, is a construction material based on polyphthalamide (copolyamide PA6T6I, PA6T/66, PA10T/X).

**Grivory GV**

The proven material for metal replacement

Grivory® GV is the trade name for a group of engineering polymers manufactured and sold by EMS-GRIVORY. Grivory GV is based on a combination of semi-crystalline and partially aromatic polyamide. Grivory is available in granulate form for processing using injection-moulding methods.

**Grilon**

Premium polyamide

Grilon® is the trade name for engineering polymers from EMS-GRIVORY based on polyamide 6, polyamide 66 and polyamide 66/6 alloys. The construction materials in this product family are semi-crystalline polyamides and are characterised by many ground-breaking properties.

**Grilamid**

Technical polymers for highest demands

Grilamid® is the brand name given by EMS-GRIVORY to its polyamide 12 products. These engineering plastics have been successfully tried and tested for more than 30 years in a wide variety of challenging applications.

**Grilamid TR**

Transparent polymers for highest requirements

The trade name Grilamid TR® designates transparent polyamides manufactured by EMS-GRIVORY. Grilamid TR grades are transparent, thermoplastically processable polyamides based on aliphatic and cyclo-aliphatic components

**Disclaimer**

The information contained in this publication is based on our present knowledge and experience. The figures and data given are guidance values and do not represent binding material specifications. No warranties of any kind, either express or implied, including warranties of merchantability or fitness for a particular purpose, are given regarding products, design, data and information. The customer is not released from his obligation to investigate the products fitness and the suitability for the intended application, compliance with legal requirements and intellectual property rights. We reserve the right to change the information at any time and without prior notice. The information in this publication is not to be considered a contractual obligation and any liability whatsoever is expressly declined. For further questions about our products please contact our experts.

Note: EMS-GRIVORY cannot assess possible future health risks which may result from direct contact of its products with blood or tissue. For this reason, EMS-GRIVORY cannot promote medical applications which involve long-term contact of plastic with blood or tissue -

Domat/Ems, October 2017



### **Delivery form**

Grivory is delivered as dry, cylindrical pellets. Standard packaging is 25 kg bags or octabins with 1000 kg capacity. Other packaging sizes on request.

### **Recycling of packaging material**

The disposal markings on our packaging materials provide a criterion for sorting and ensure segregated disposal

### **LFT link**

Further information about long fibre reinforced polyamides can be found on our website:

**[www.emsgrivory.com](http://www.emsgrivory.com)**



## EMS-GRIVORY worldwide

[www.emsgrivory.com](http://www.emsgrivory.com)

### EMS-GRIVORY - The leading manufacturer of high-performance polyamides

EMS-GRIVORY is the leading manufacturer of high-performance polyamides and the supplier with the widest range of polyamide materials. Our products are well-known throughout the world under the trademarks Grilamid, Grivory and Grilon.

We offer our customers a comprehensive package of high-capacity and high-quality products along with segment-specific advisory competence in distribution and application development. We maintain our market leadership through continual product and application development in all segments.

### EMS-GRIVORY Europe

#### Switzerland

EMS-CHEMIE AG  
Business Unit EMS-GRIVORY Europe  
Via Innovativa 1  
7013 Domat/Ems  
Switzerland  
Phone +41 81 632 78 88  
Fax +41 81 632 76 65  
[welcome@emsgrivory.com](mailto:welcome@emsgrivory.com)

#### Germany

EMS-CHEMIE (Deutschland) Vertriebs GmbH  
Warthweg 14  
64823 Gross-Umstadt  
Deutschland  
Phone +49 6078 783 0  
Fax +49 6078 783 416  
[welcome@de.emsgrivory.com](mailto:welcome@de.emsgrivory.com)

#### France

EMS-CHEMIE (France) S.A.  
855 Avenue Roger Salengro  
Boîte postale 16  
92370 Chaville  
France  
Phone +33 1 41 10 06 10  
Fax +33 1 48 25 56 07  
[welcome@fr.emsgrivory.com](mailto:welcome@fr.emsgrivory.com)

#### Great Britain

EMS-CHEMIE (UK) Ltd.  
Darfin House, Priestly Court  
Staffordshire Technology Park  
Stafford ST18 0LQ  
Great Britain  
Phone +44 1785 283 739  
Fax +44 1785 283 722  
[welcome@uk.emsgrivory.com](mailto:welcome@uk.emsgrivory.com)

EMS-GRIVORY,  
a business unit of the EMS Group

#### Italy

EMS-CHEMIE (Italia) S.r.l.  
Via Carloni 56  
22100 Como (CO)  
Italia  
Phone +39 011 0604522  
Fax +39 011 0604522  
[welcome@it.emsgrivory.com](mailto:welcome@it.emsgrivory.com)

### EMS-GRIVORY Asia

#### China

EMS-CHEMIE (China) Ltd.  
227 Songbei Road  
Suzhou Industrial Park  
Suzhou City 215126  
Jiangsu Province  
P.R. China  
Phone +86 512 8666 8180  
Fax +86 512 8666 8210  
[welcome@cn.emsgrivory.com](mailto:welcome@cn.emsgrivory.com)

EMS-CHEMIE (Suzhou) Ltd.  
227 Songbei Road  
Suzhou Industrial Park  
Suzhou City 215126  
Jiangsu Province  
P.R. China  
Phone +86 512 8666 8181  
Fax +86 512 8666 8183  
[welcome@cn.emsgrivory.com](mailto:welcome@cn.emsgrivory.com)

#### Taiwan

EMS-CHEMIE (Taiwan) Ltd.  
36, Kwang Fu South Road  
Hsin Chu Industrial Park  
Fu Kou Hsiang  
Hsin Chu Hsien 30351  
Taiwan, R.O.C.  
Phone +886 3 598 5335  
Fax +886 3 598 5345  
[welcome@tw.emsgrivory.com](mailto:welcome@tw.emsgrivory.com)

#### Korea

EMS-CHEMIE (Korea) Ltd.  
#817 Doosan Venturedigm,  
415 Heungan Daero,  
Dongan-gu, Anyang-si,  
Gyeonggi-do, 431-755  
Republic of Korea  
Phone +82 31 478 3159  
Fax +82 31 478 3157  
[welcome@kr.emsgrivory.com](mailto:welcome@kr.emsgrivory.com)

#### Japan

EMS-CHEMIE (Japan) Ltd.  
EMS Building  
2-11-20 Higashi-koujiya  
Ota-ku, Tokyo 144-0033  
Japan  
Phone +81 3 5735 0611  
Fax +81 3 5735 0614  
[welcome@jp.emsgrivory.com](mailto:welcome@jp.emsgrivory.com)

### EMS-GRIVORY America

#### United States of America

EMS-CHEMIE (North America) Inc.  
2060 Corporate Way  
P.O. Box 1717  
Sumter, SC 29151  
USA  
Phone +1 803 481 61 71  
Fax +1 803 481 61 21  
[welcome@us.emsgrivory.com](mailto:welcome@us.emsgrivory.com)

**EMS**  
EMS-GRIVORY